

LOFAR

Hardware Status

André W. Gunst

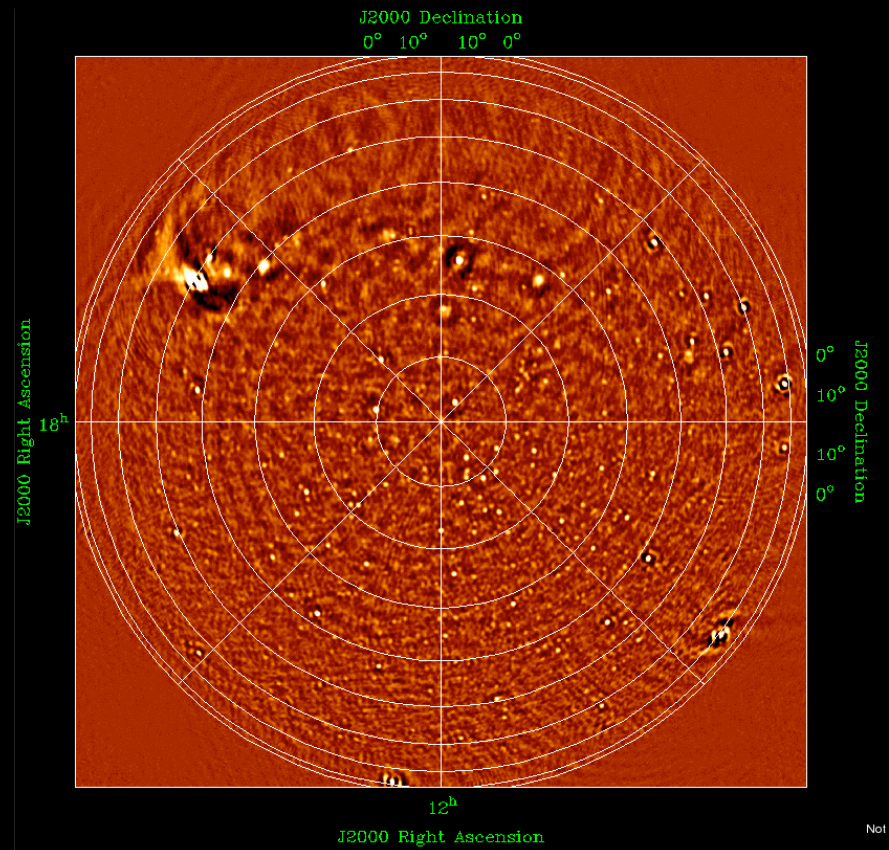

- Stations
- Central Systems
- Control System

The Instrument

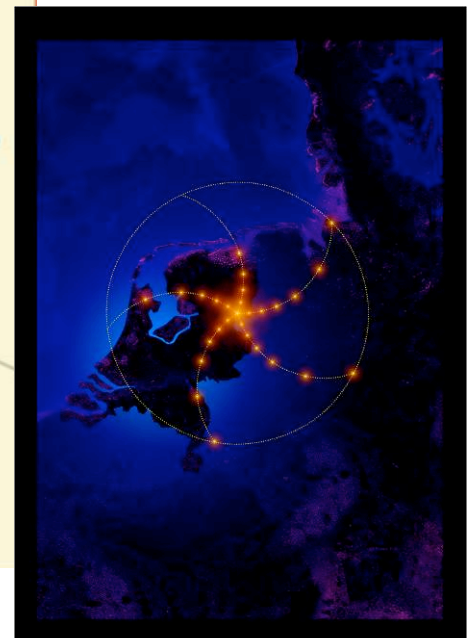
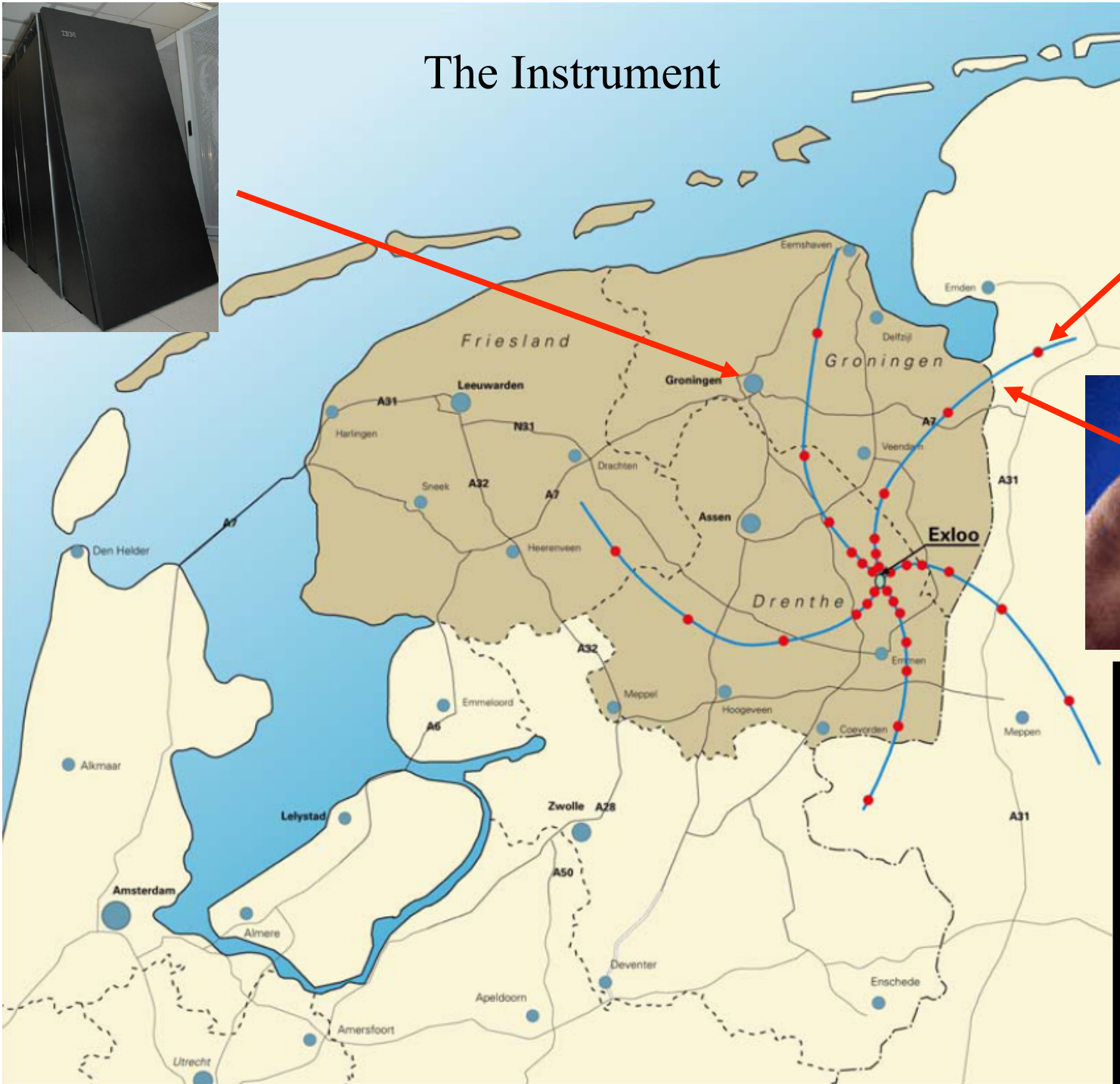

- International stations: 96 High Band Antennas
- Remote stations: 48 HBAs
- Core stations: 2x24 HBAs

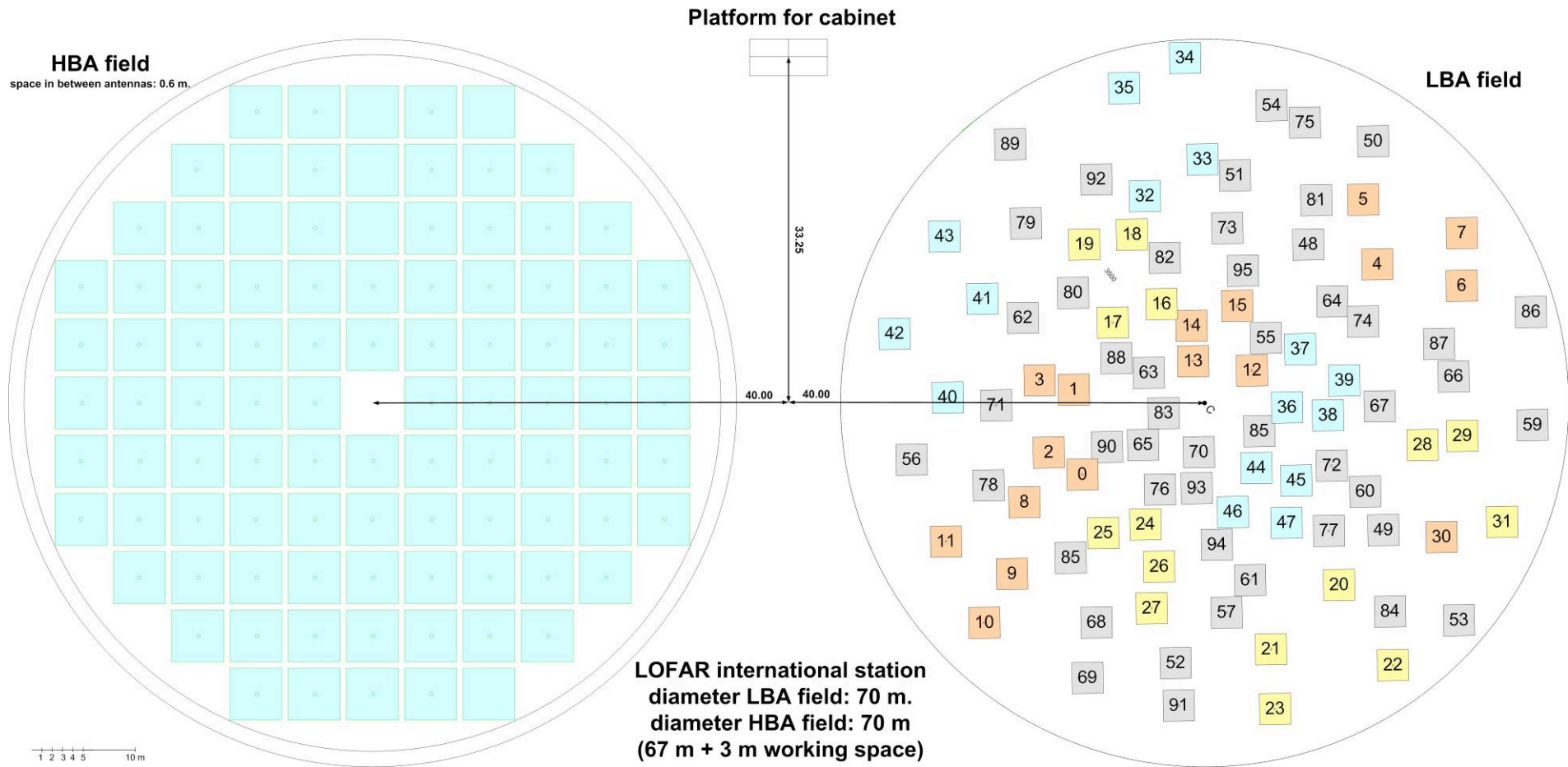

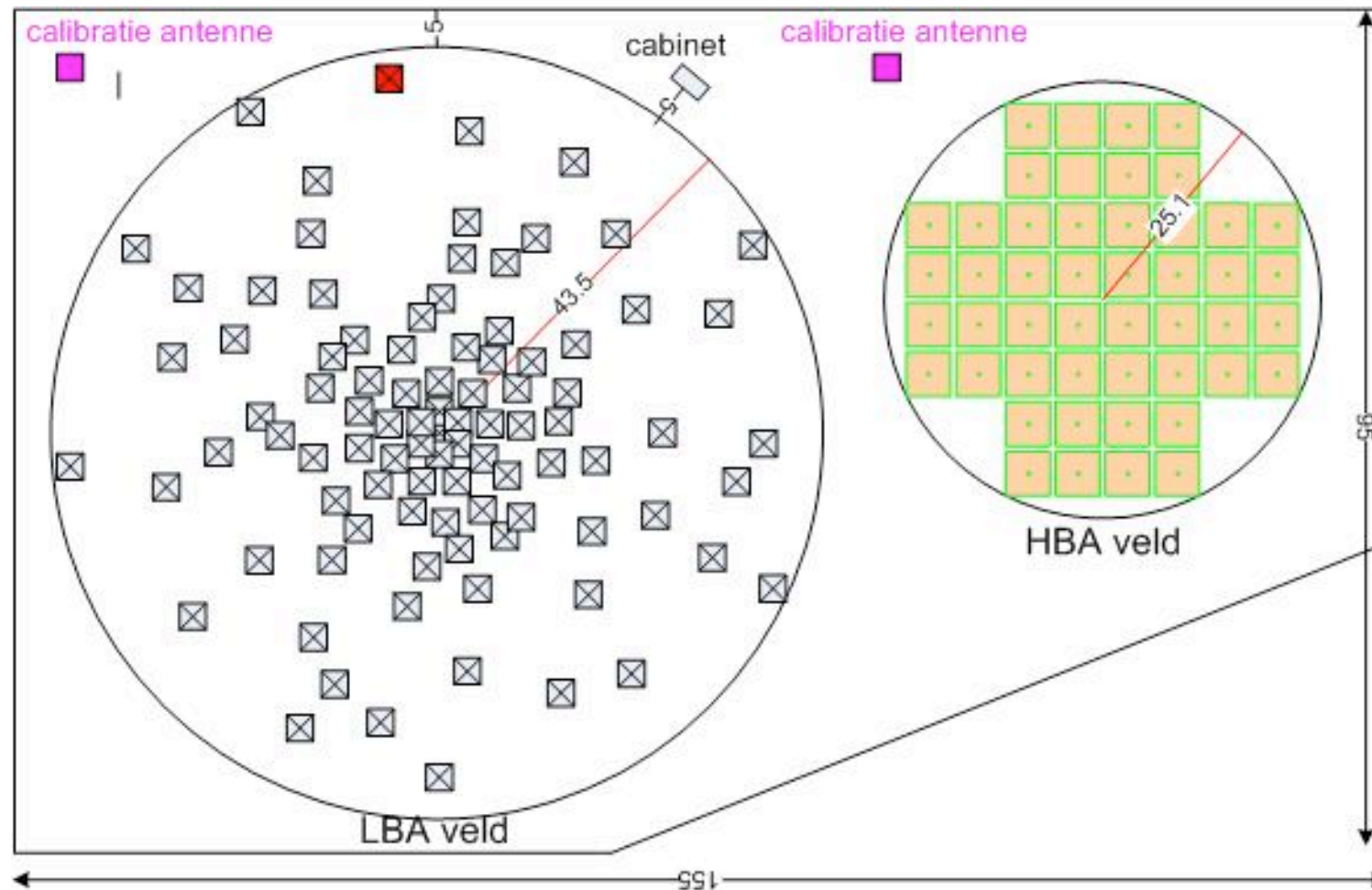

LOFAR remote station:

=> LBA veld heeft diameter van 87 meter en bevat 96 antennes

=> HBA veld heeft diameter van 50.2 meter en bevat 48 antennes

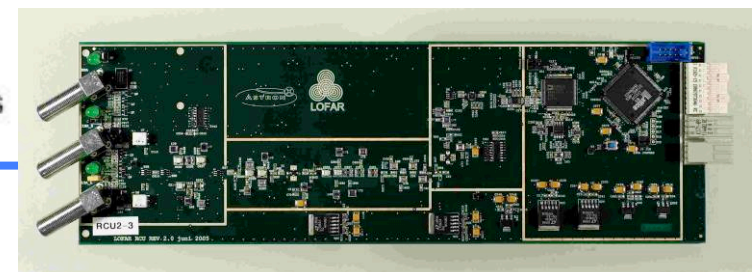

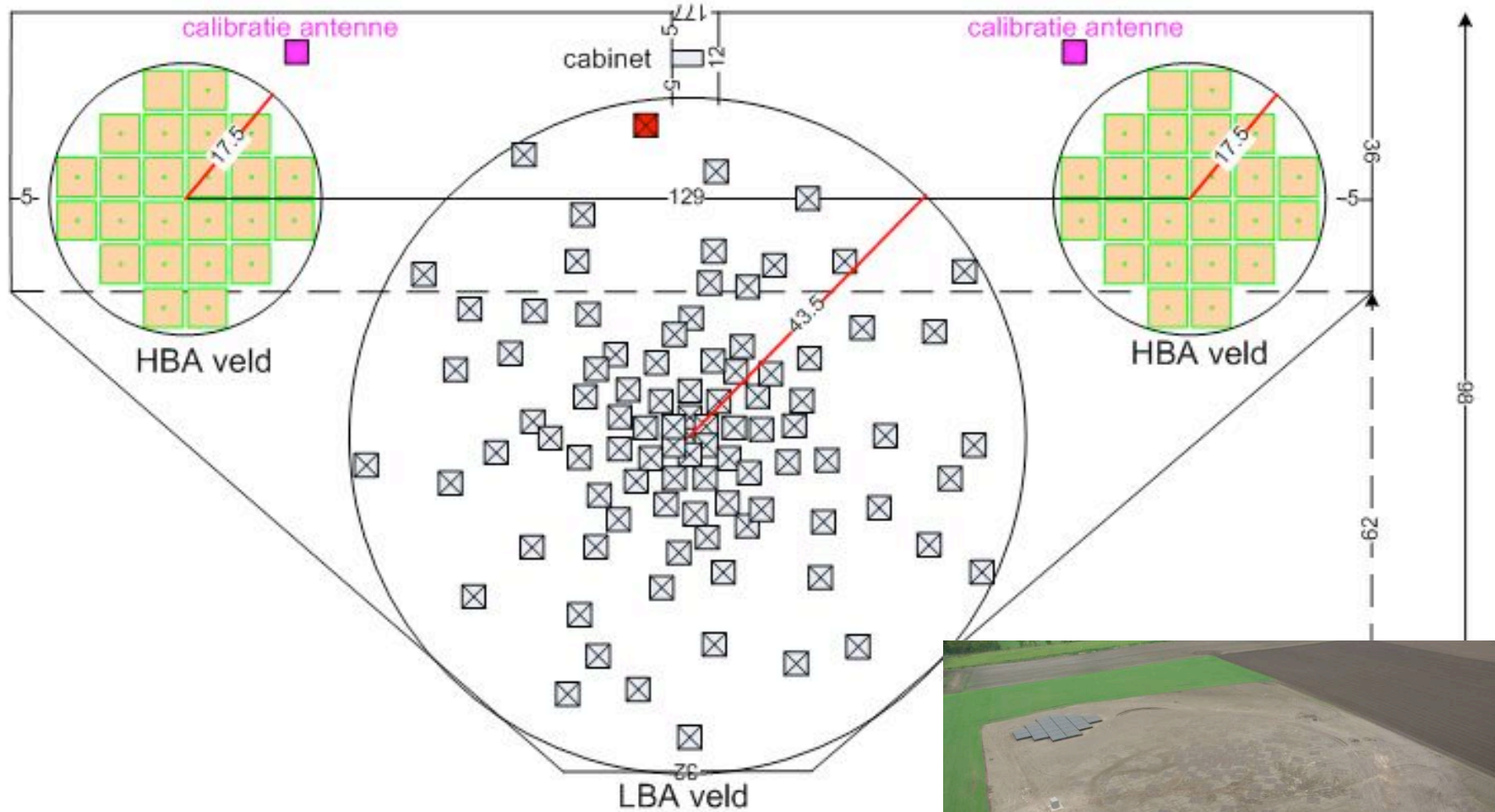

LOFAR CORE station:

=> LBA veld heeft diameter van 87 meter en bevat 96 antennes

=> 2 HBA velden (elk met een diameter van 35 meter) bevatten elk 24 antennes



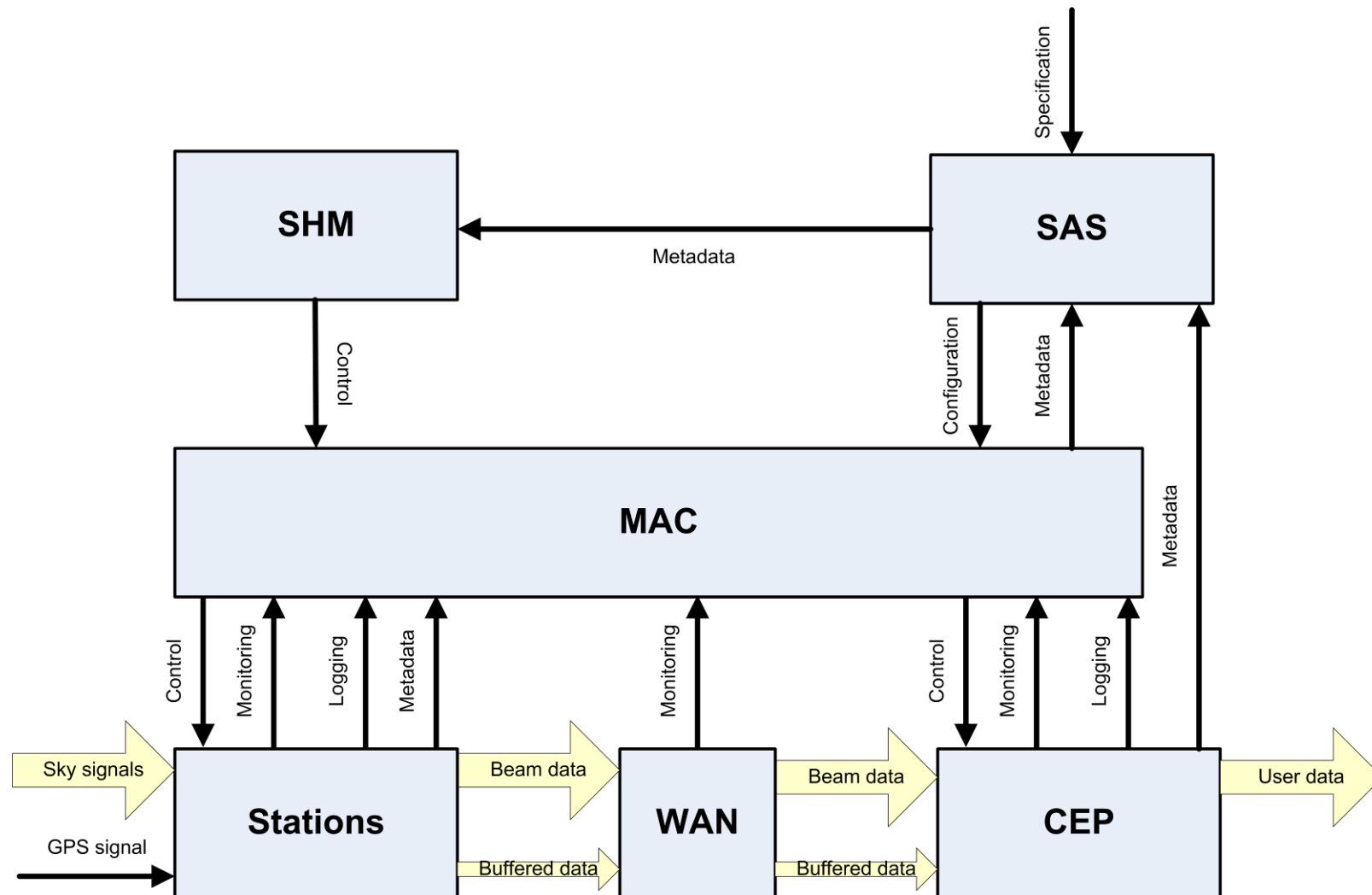

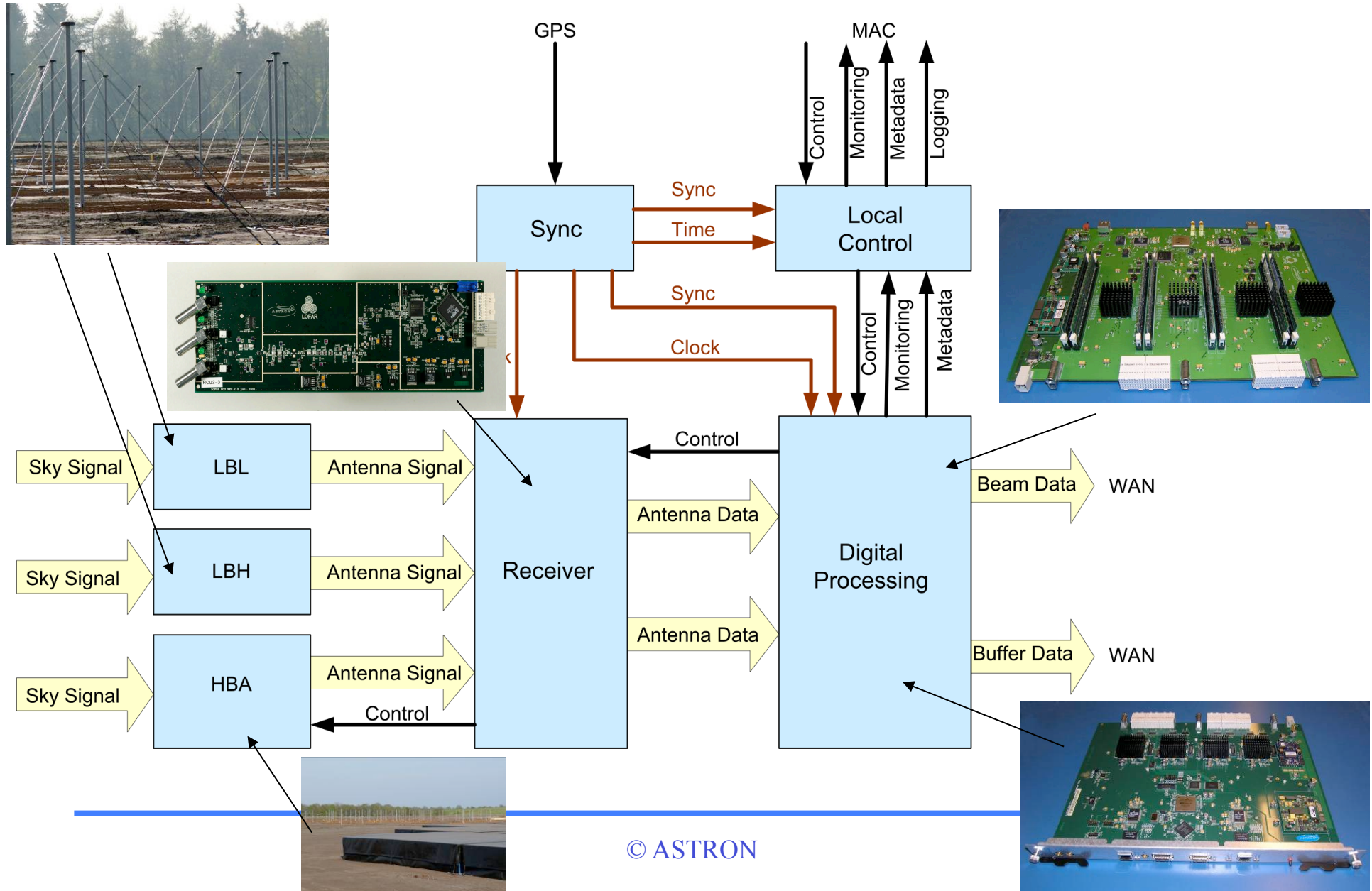

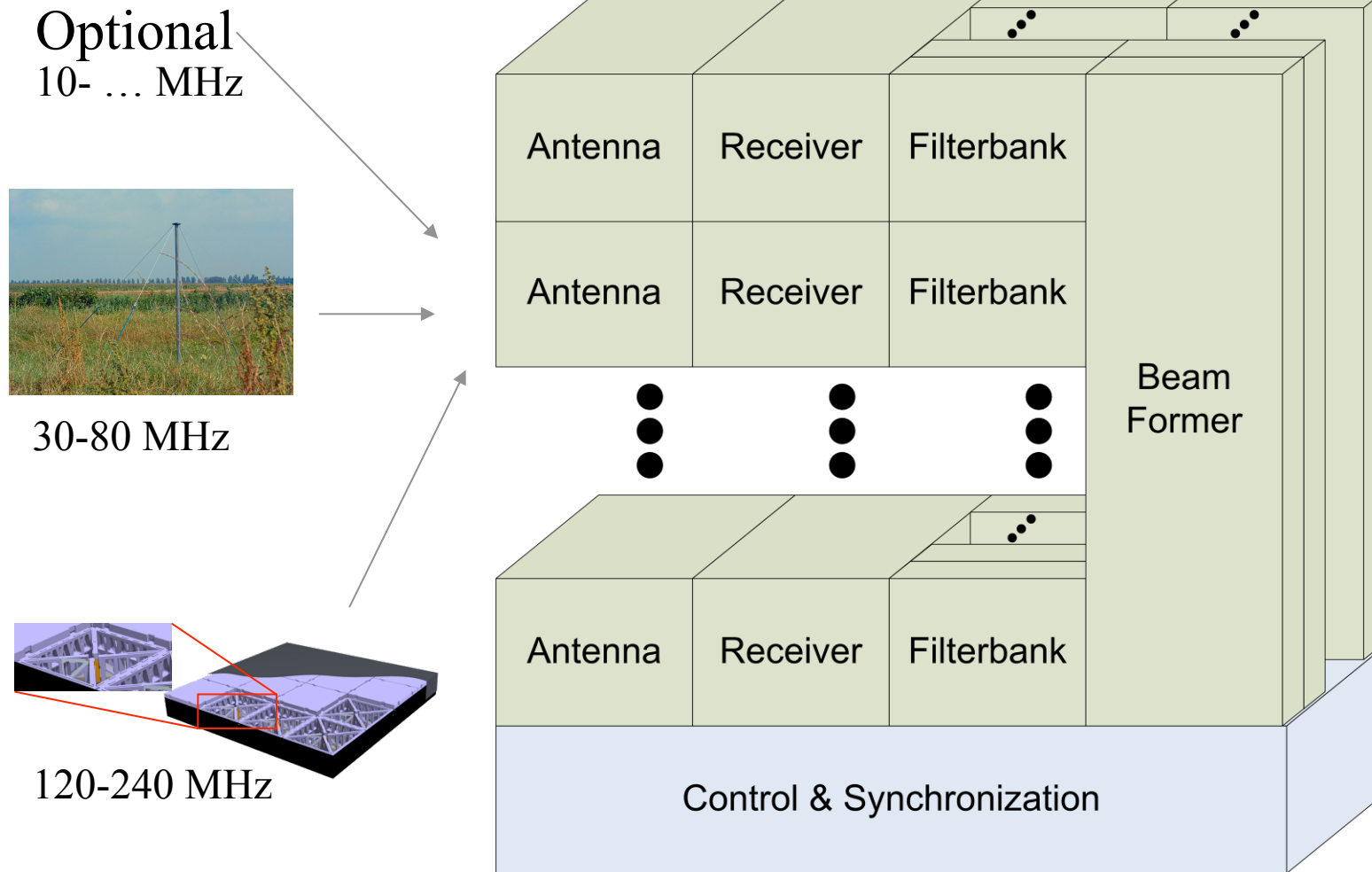

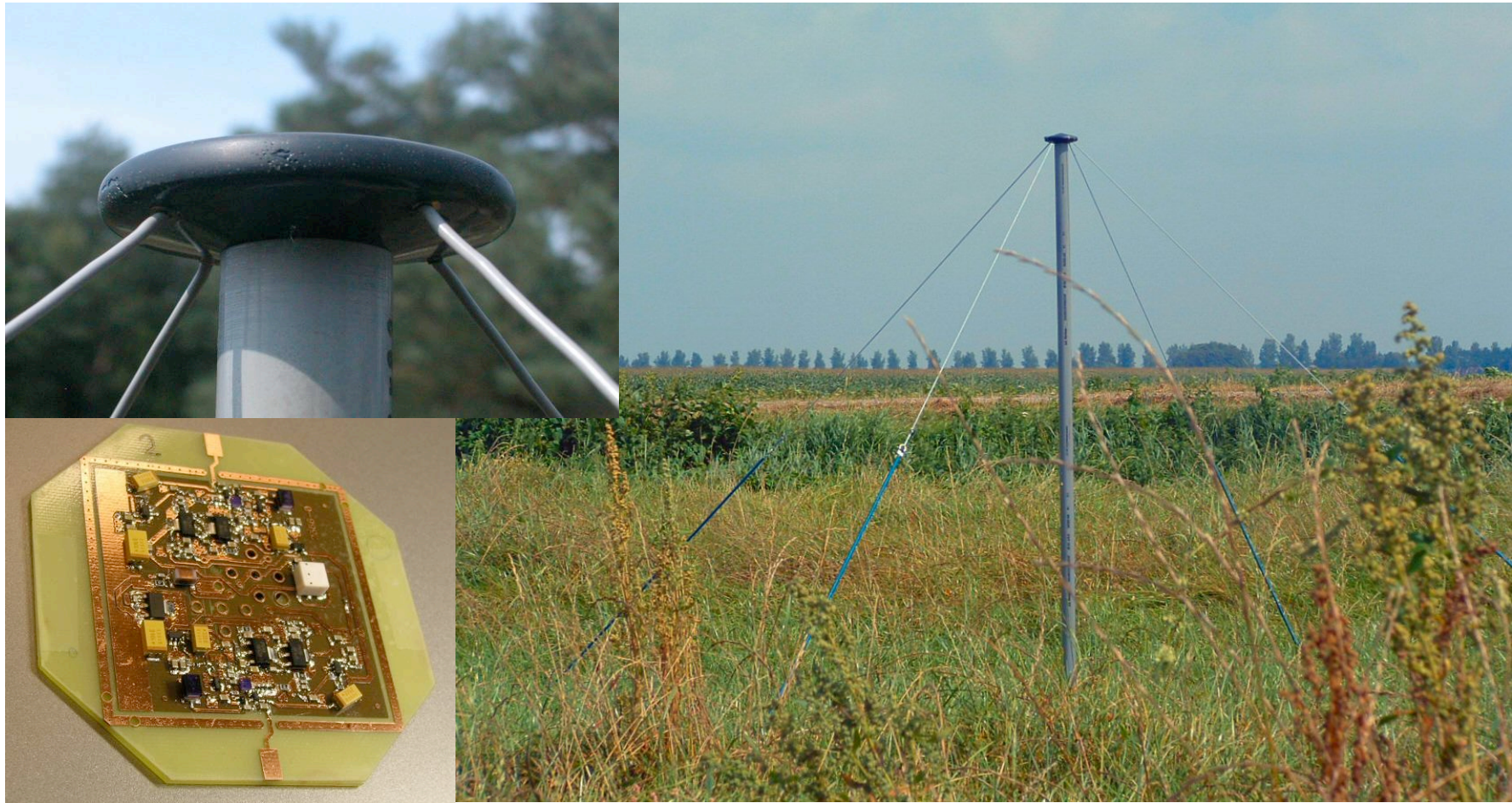

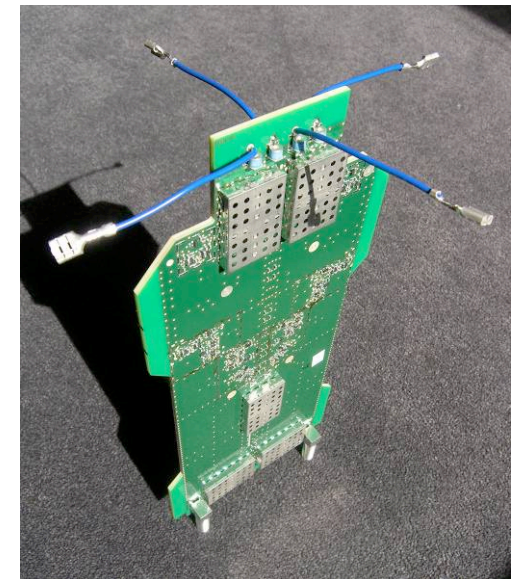
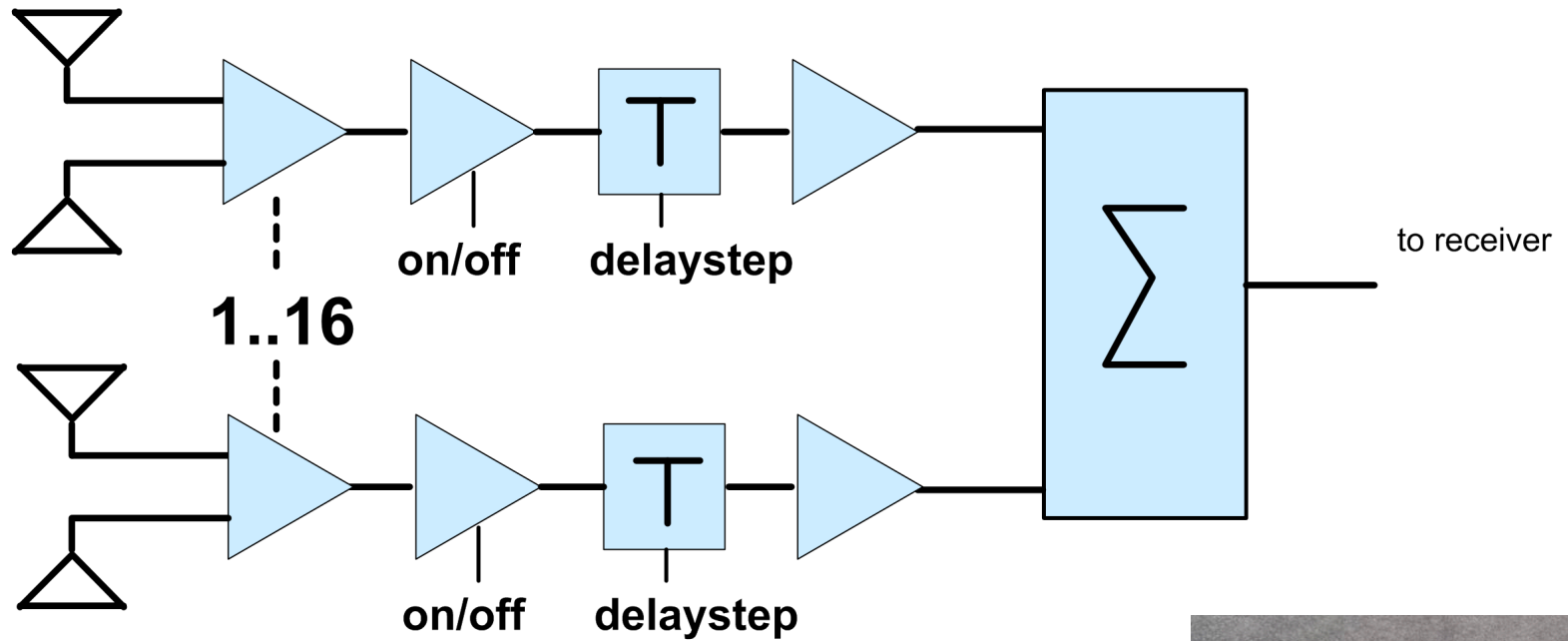

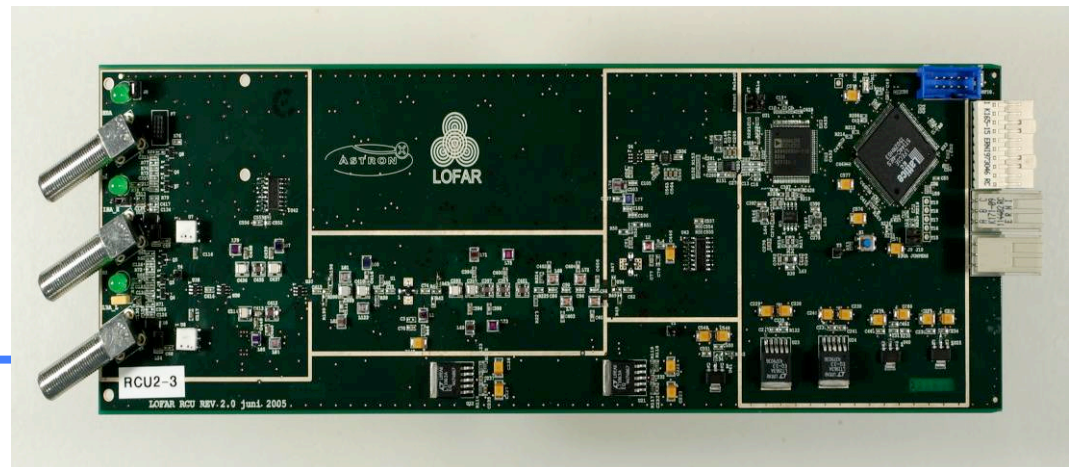
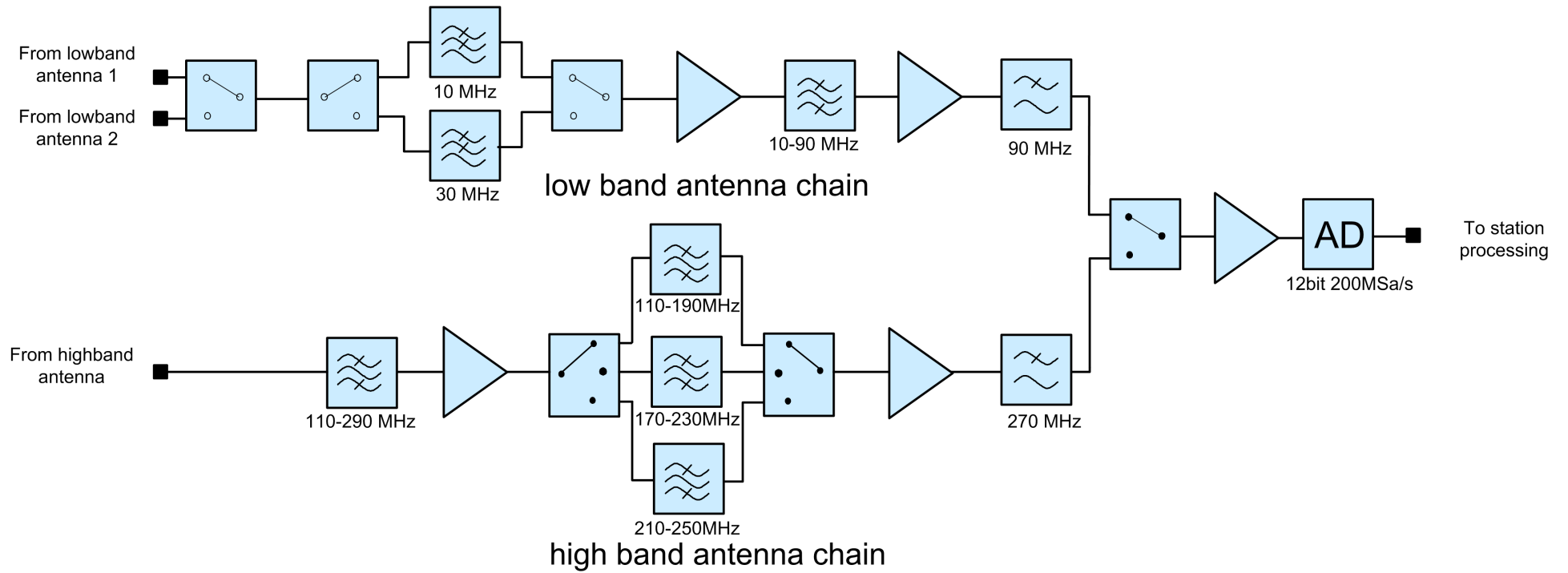

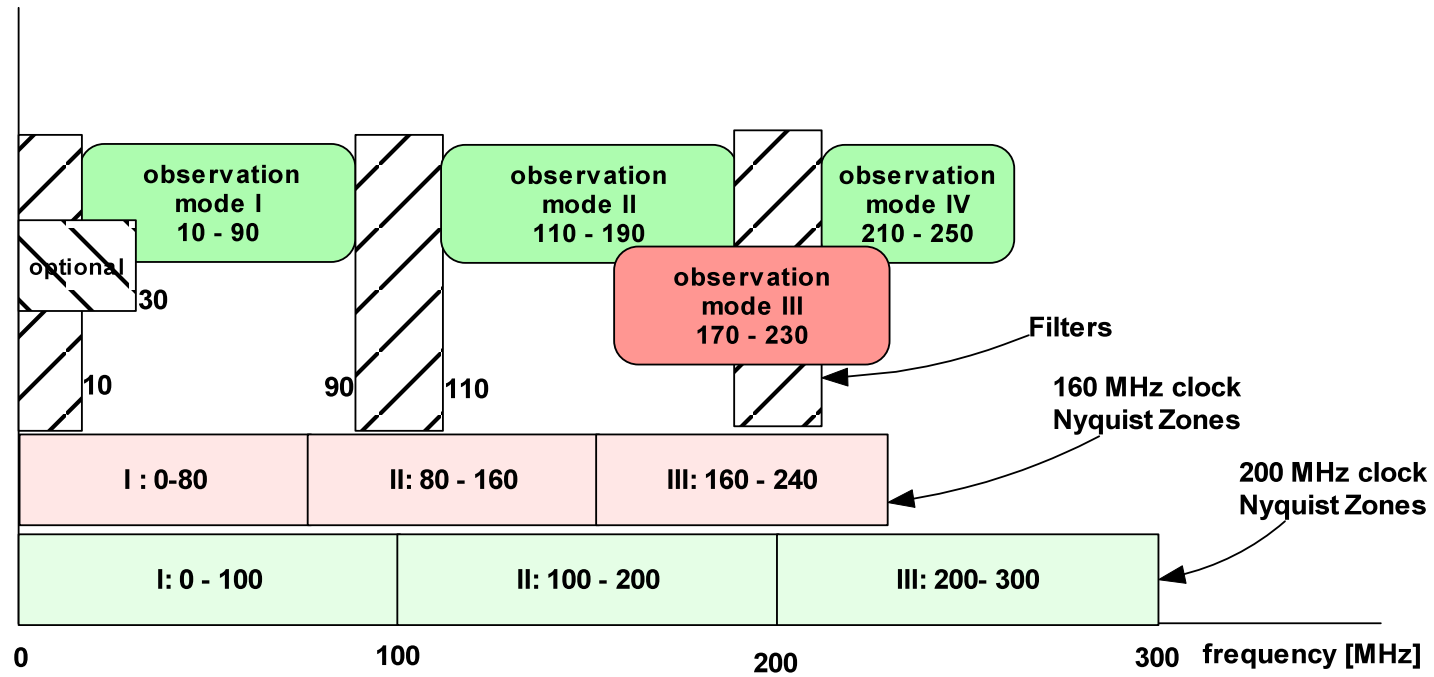

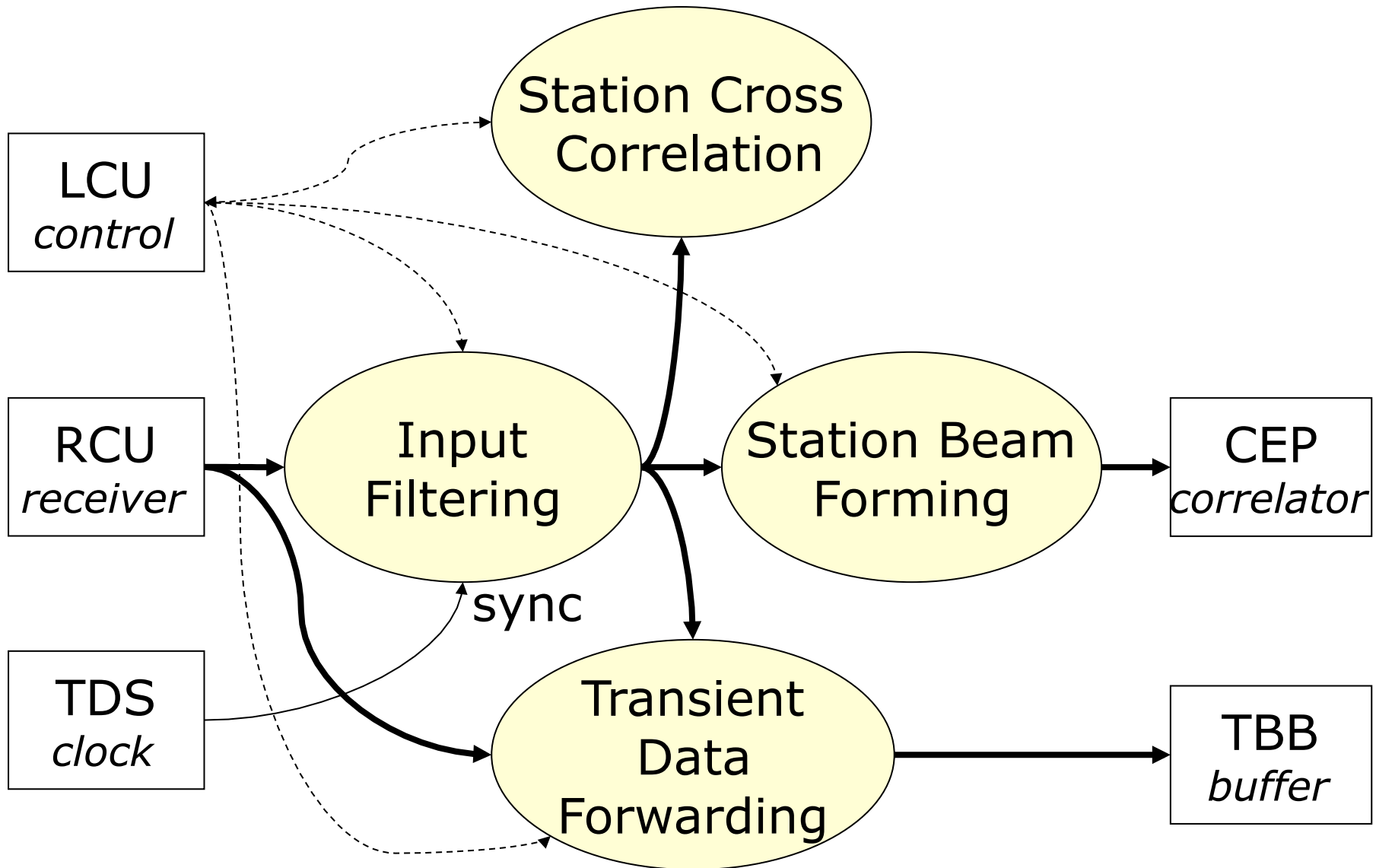

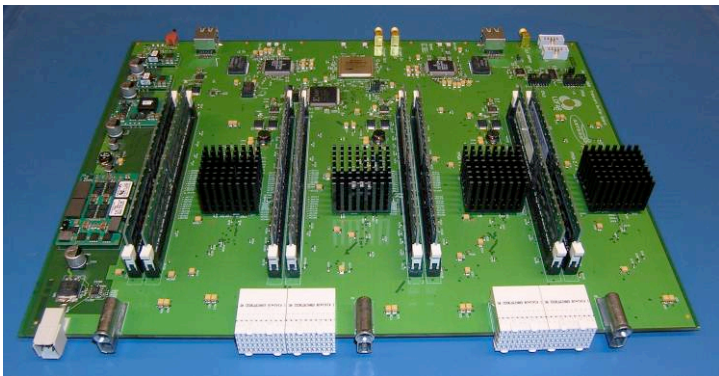
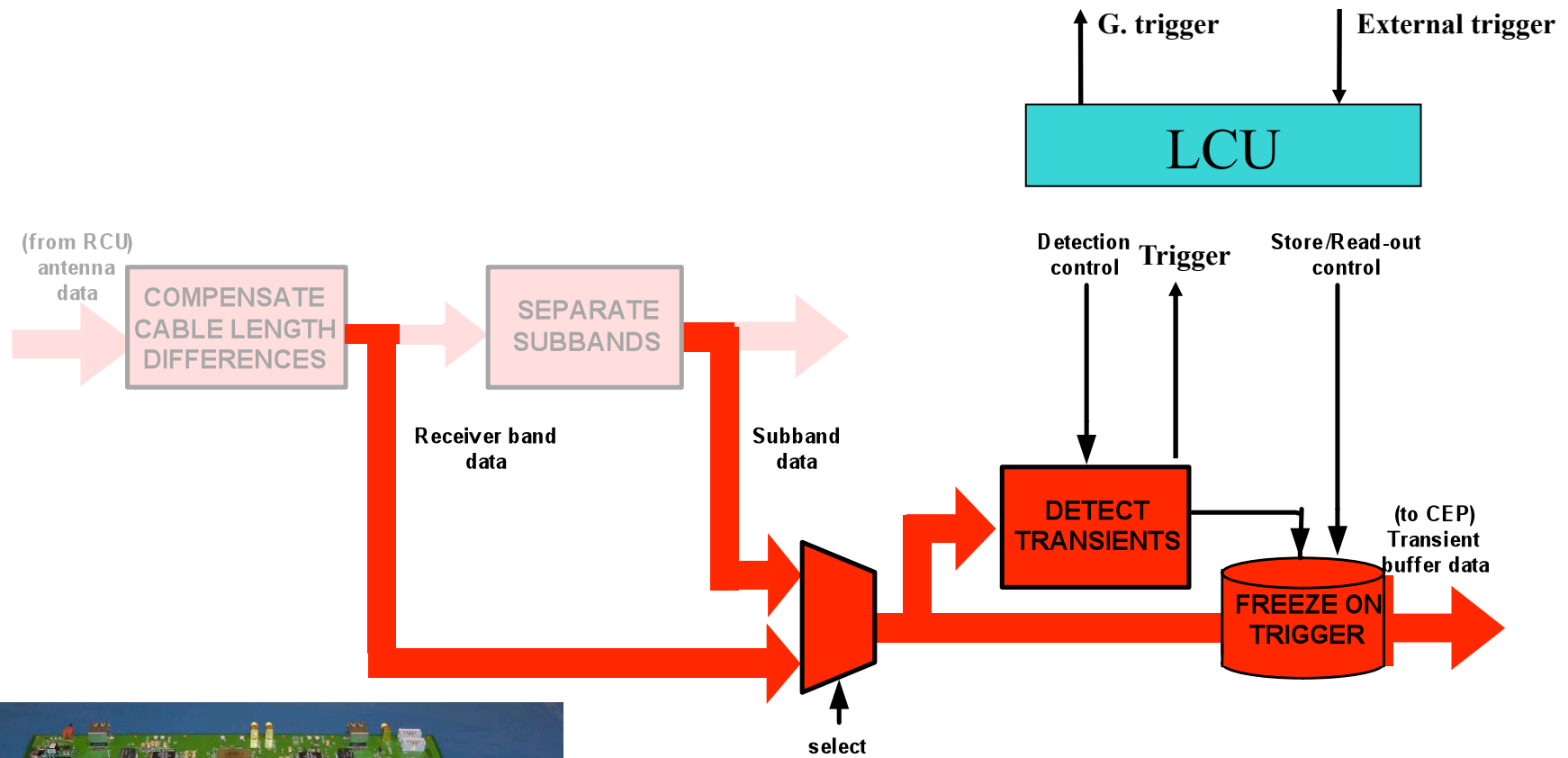

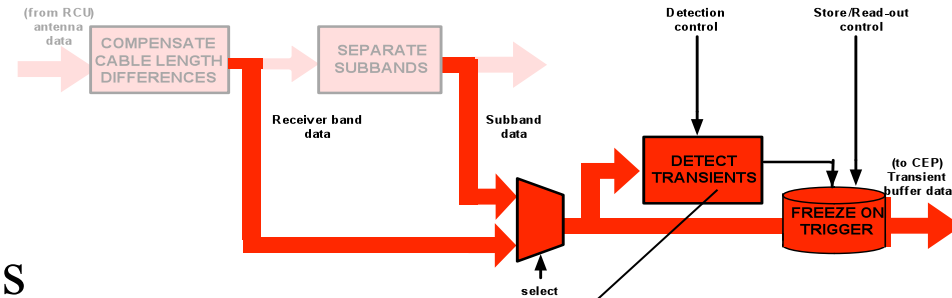

to suppress strong RFI signals
at fixed locations

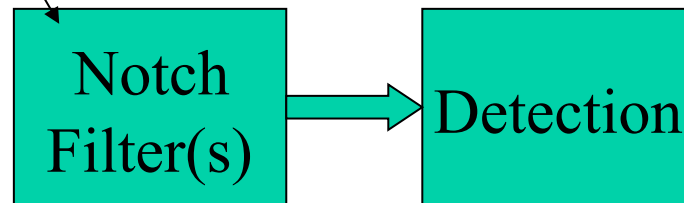

Detection only possible on the stored signals

Superterp (trigger infrastructure)

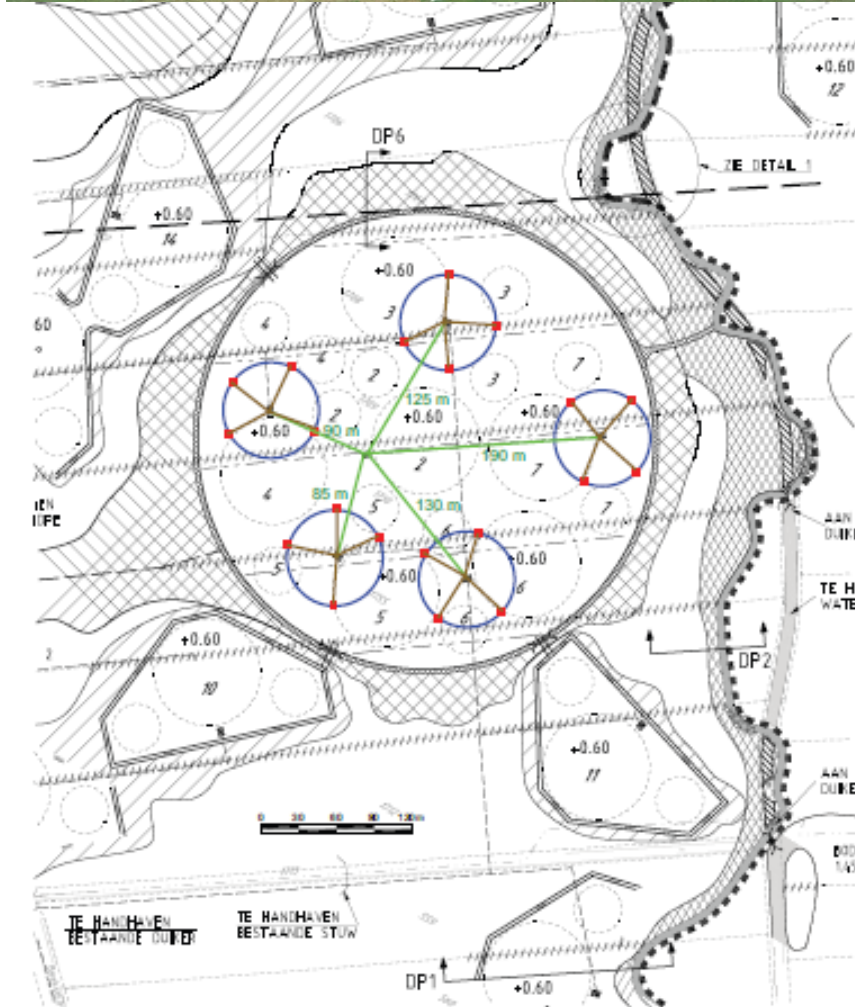
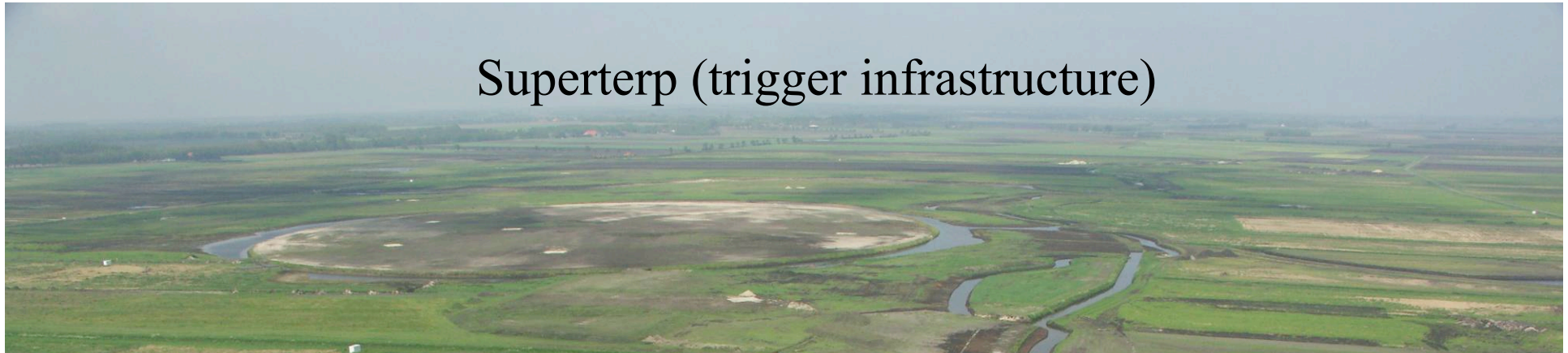

- Station Acceptance/Validation Procedure:
 - ☞ basic hardware tests
 - ☞ checks individual antenna performances
 - ☞ checks basic functionalities and interconnections
 - ☞ results in a report including the test results
- Formal Station Acceptance by RO:
 - ☞ quantifies top level requirements
 - linearity
 - sensitivity ($A_{\text{eff}}/T_{\text{sys}}$)
 - power consumption

- Central Systems acceptance procedure
 - ☞ station remote access
 - ☞ station (RSP) – CEP interface
 - ☞ station (TBB) – CEP interface
 - ☞ Navigator – station interface
 - ☞ MAC/SAS – station interface
 - ☞ SHM – MAC/SAS – station interface
- Commissioning acceptance procedure
 - ☞ checks for fringes
 - ☞ ... to be discussed tomorrow

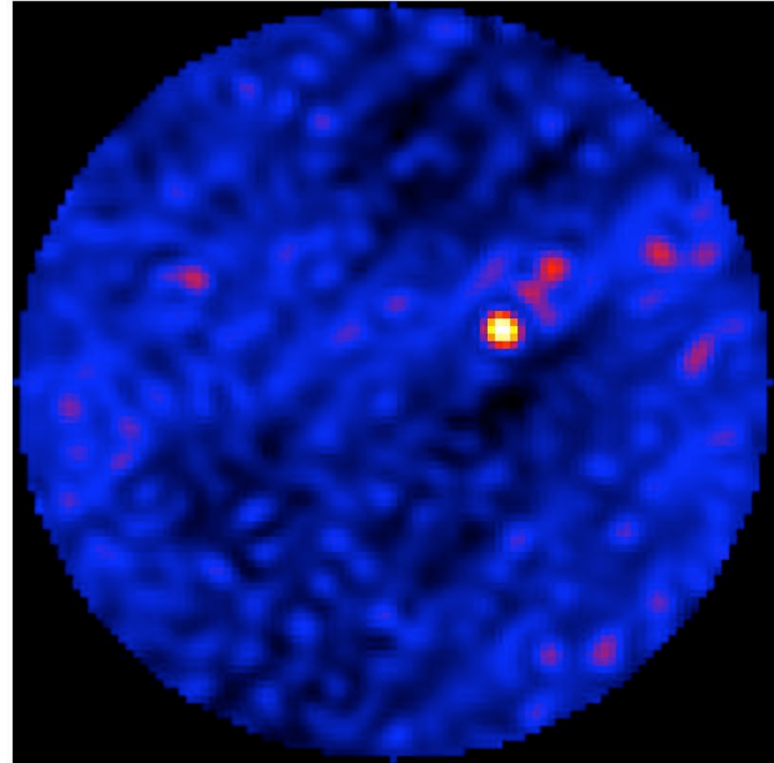
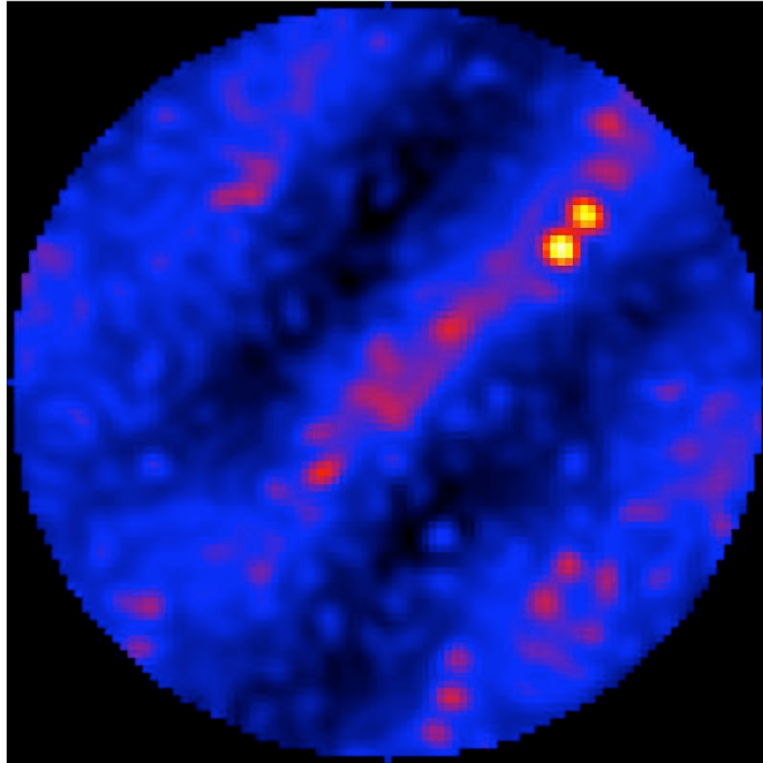

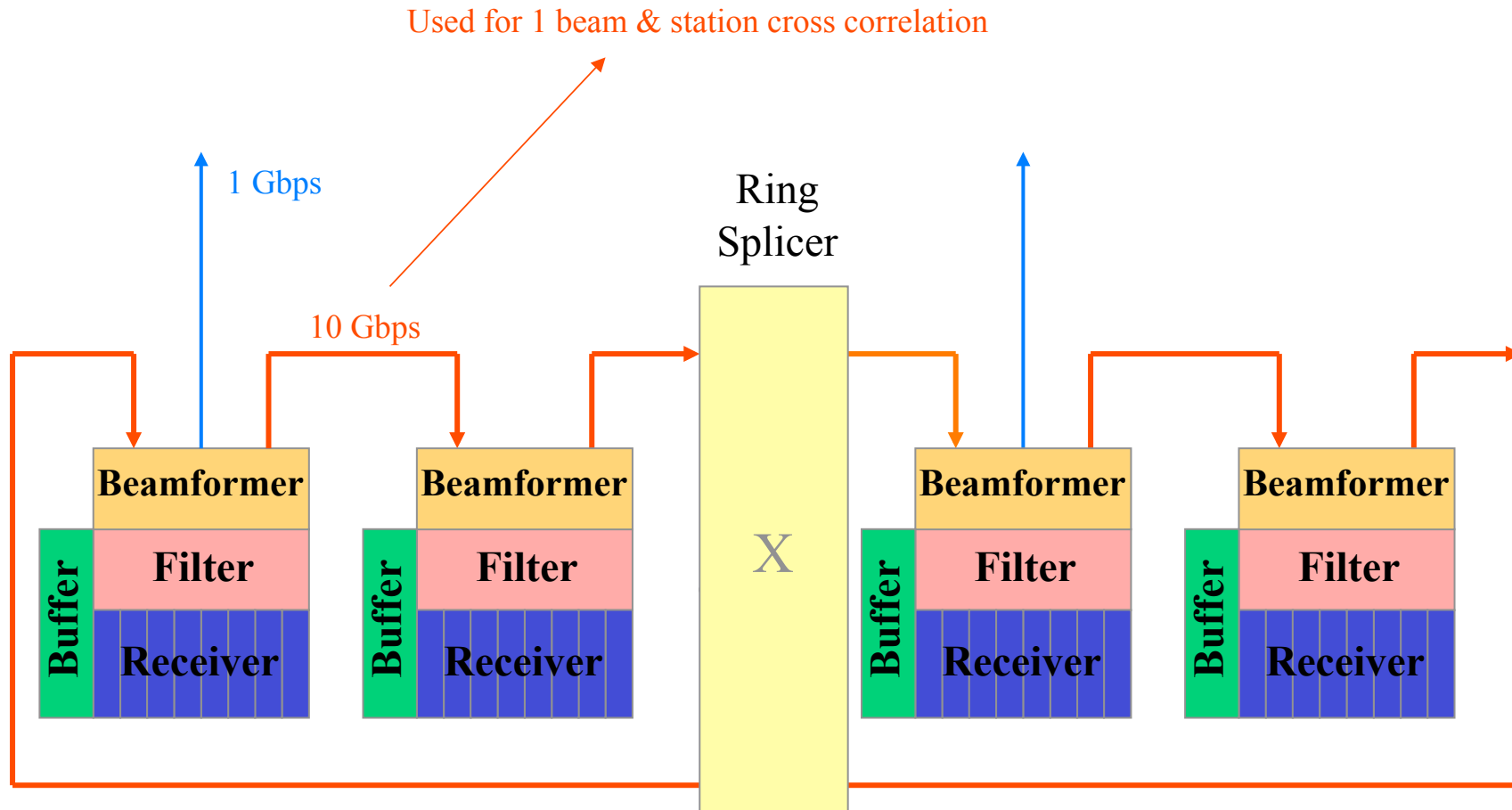

Expected availability: August 2009

d:\LOFAR\dataCS302\20090516_123406_sst_rcu094.dat time=2

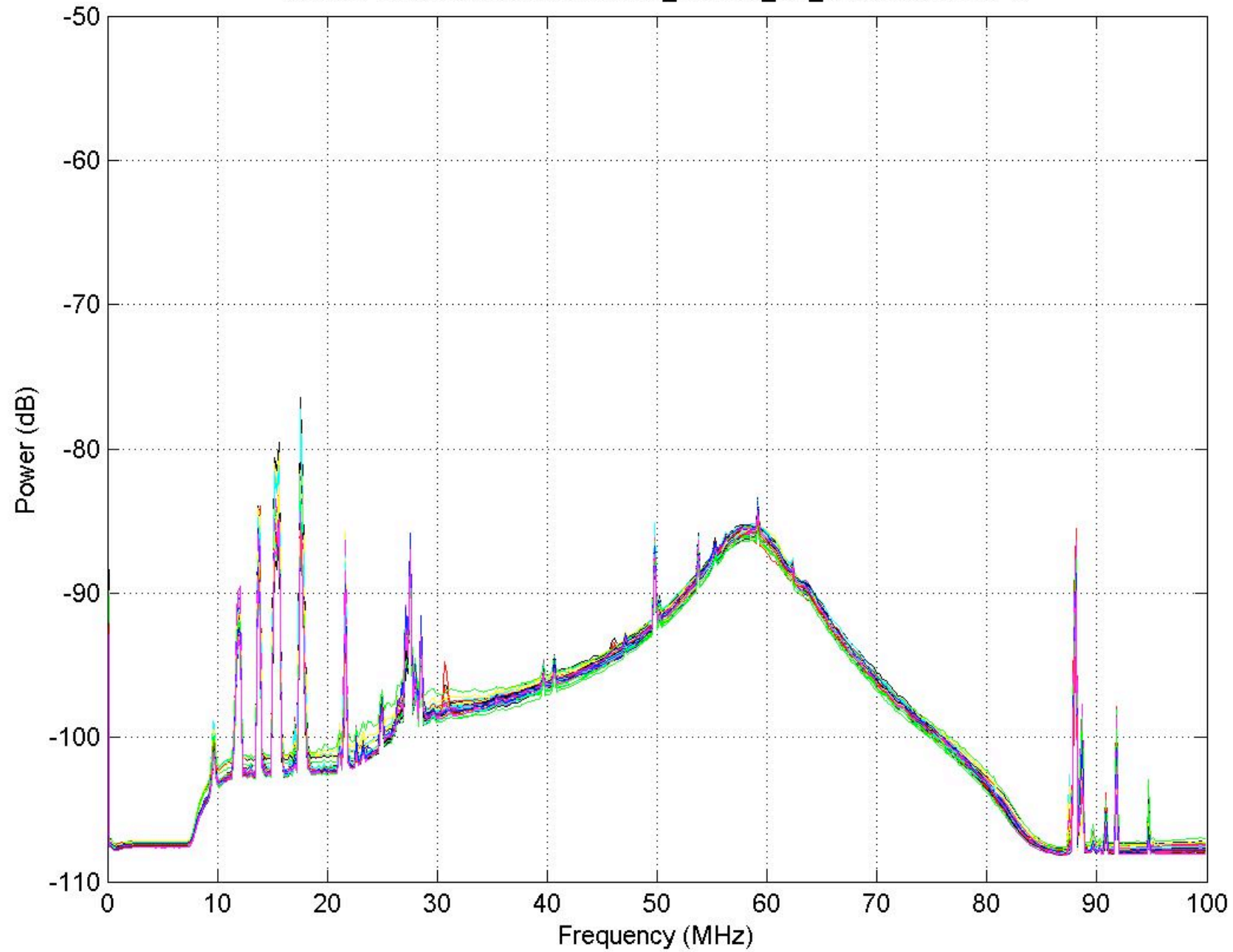

d:\LOFAR\dataCS302\20090516_123406_sst_rcu095.dat time=2

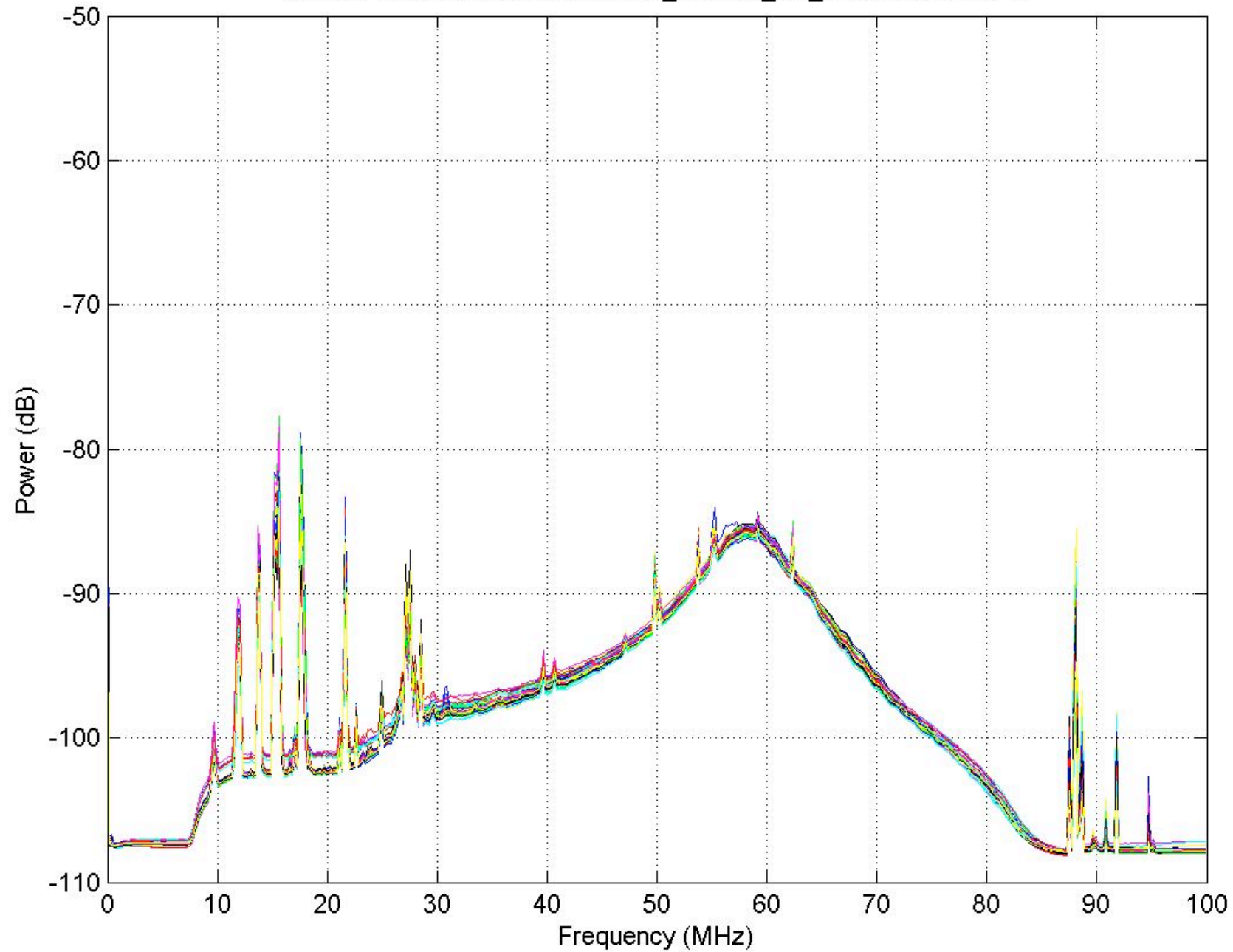

d:\LOFAR\dataCS302\20090516_123406_sst_rcu094.dat subband=250

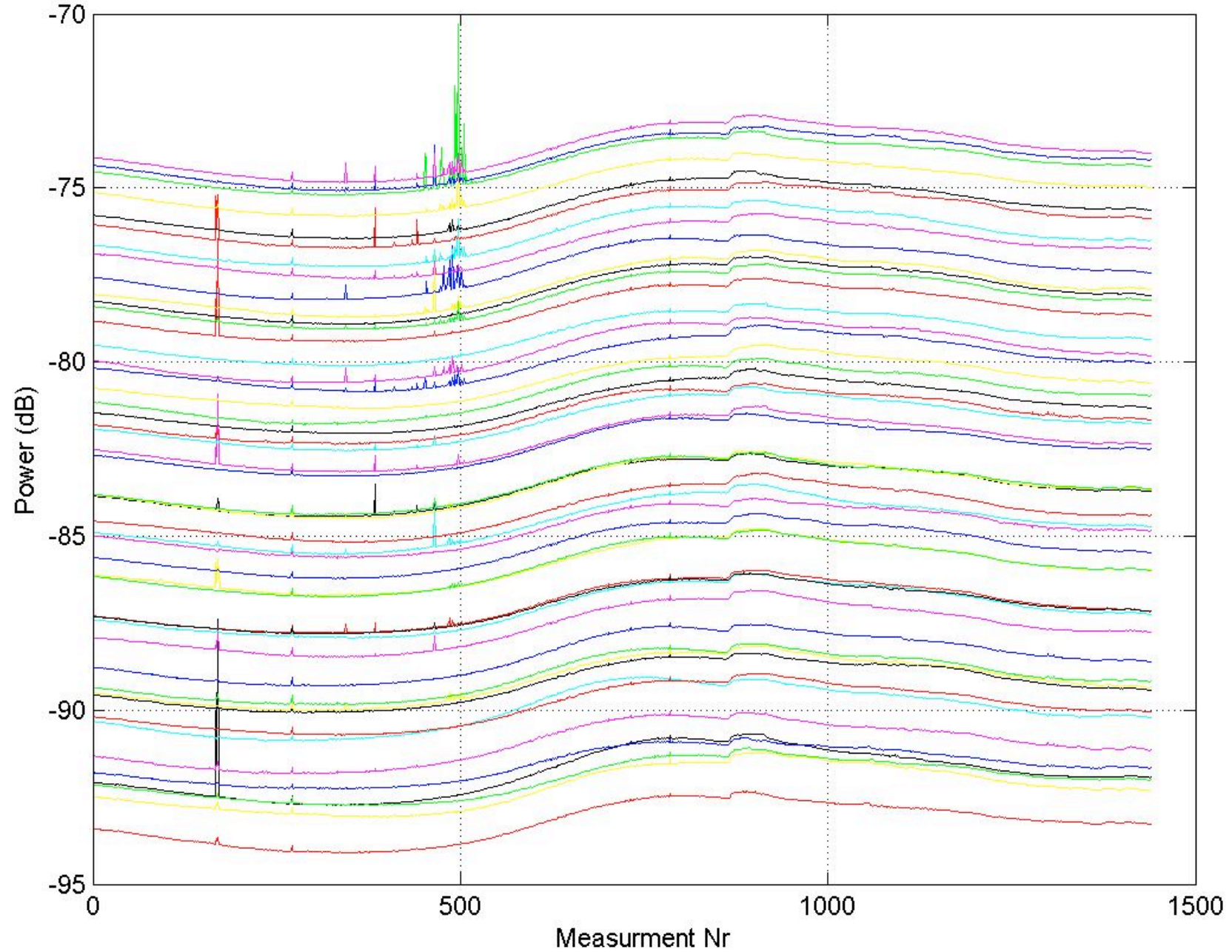

d:\LOFAR\dataCS302\20090516_123406_sst_rcu095.dat subband=250

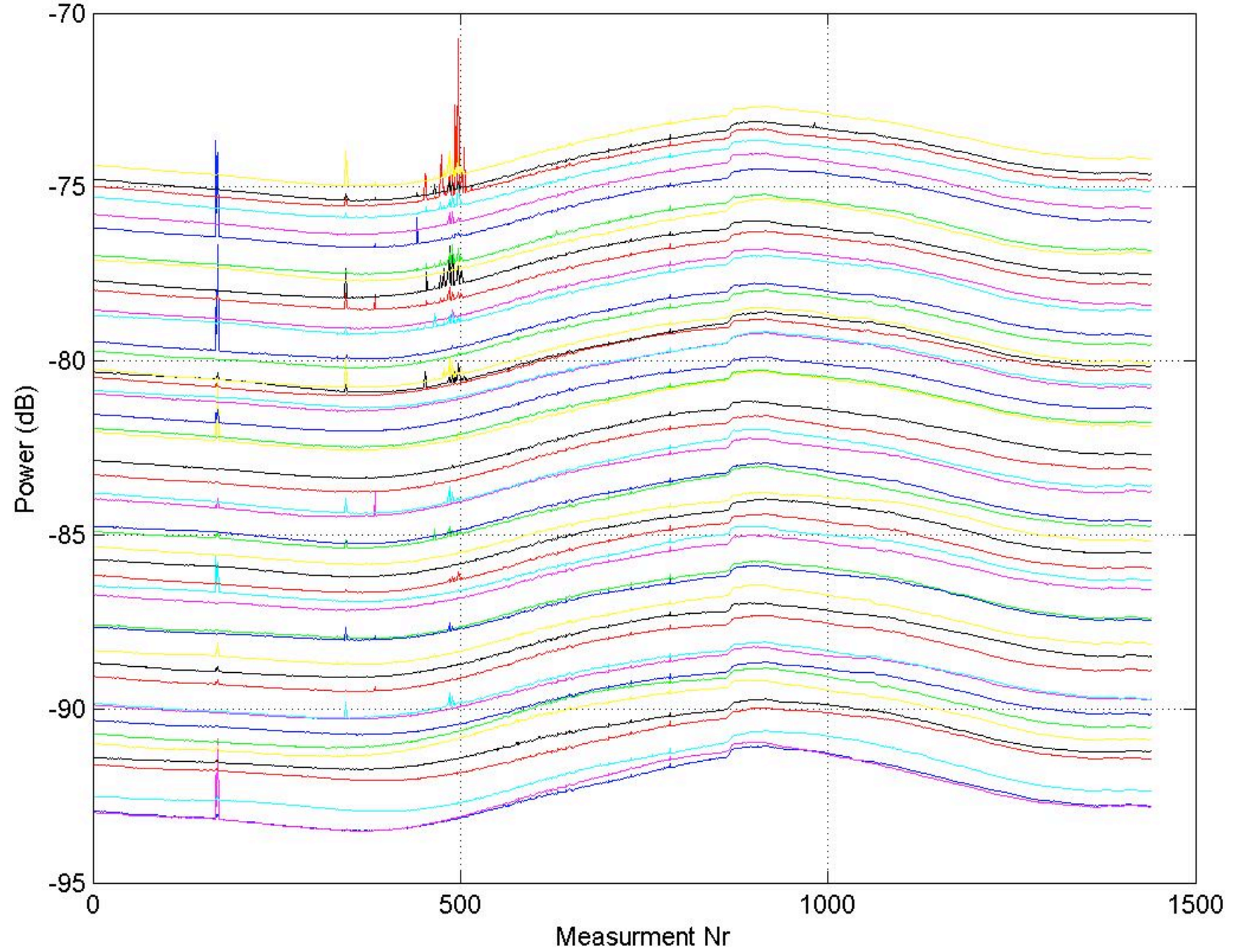

$\times 10^7$

Power of d:\LOFAR\data\20090424_170809_sst_rcu095.dat

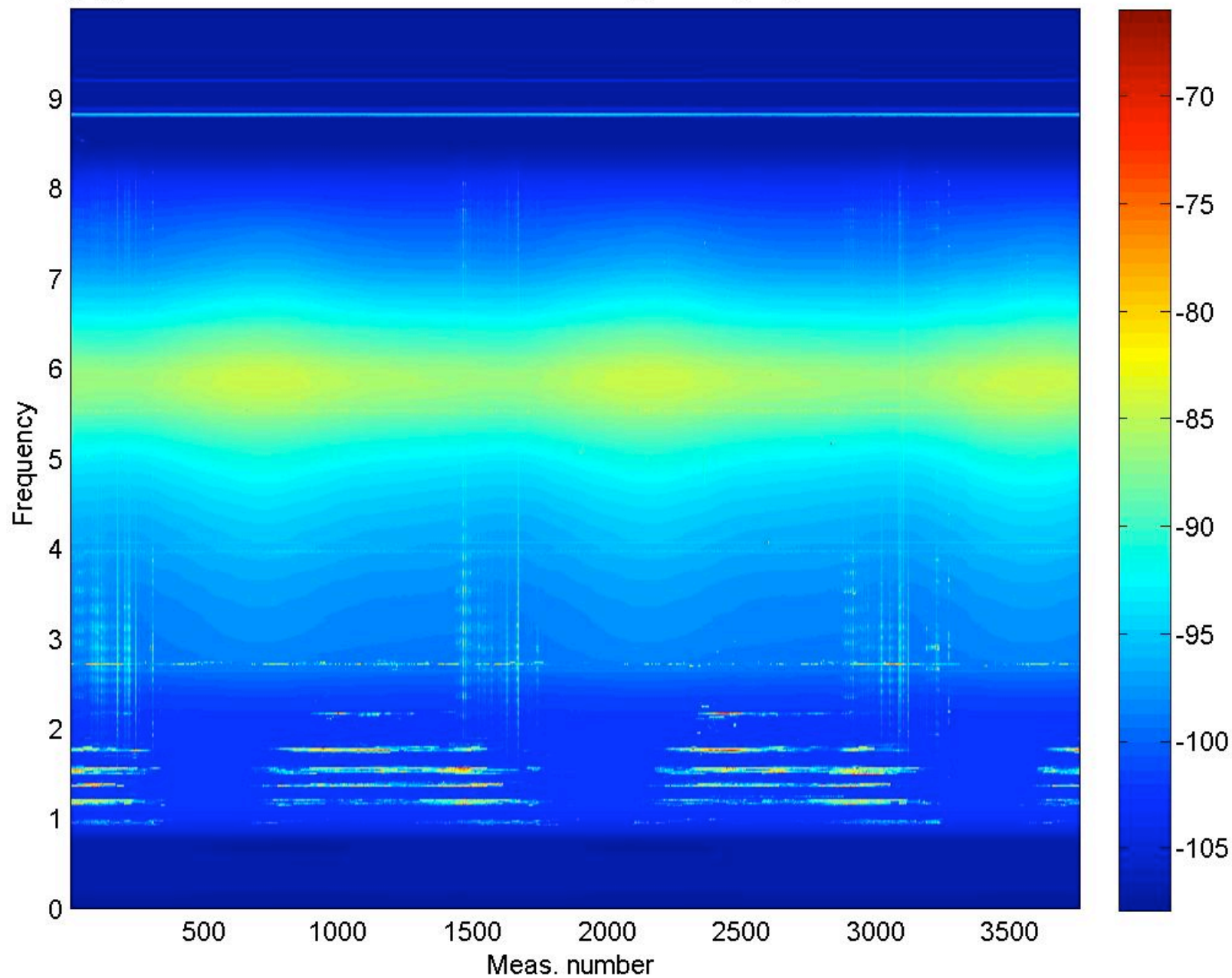

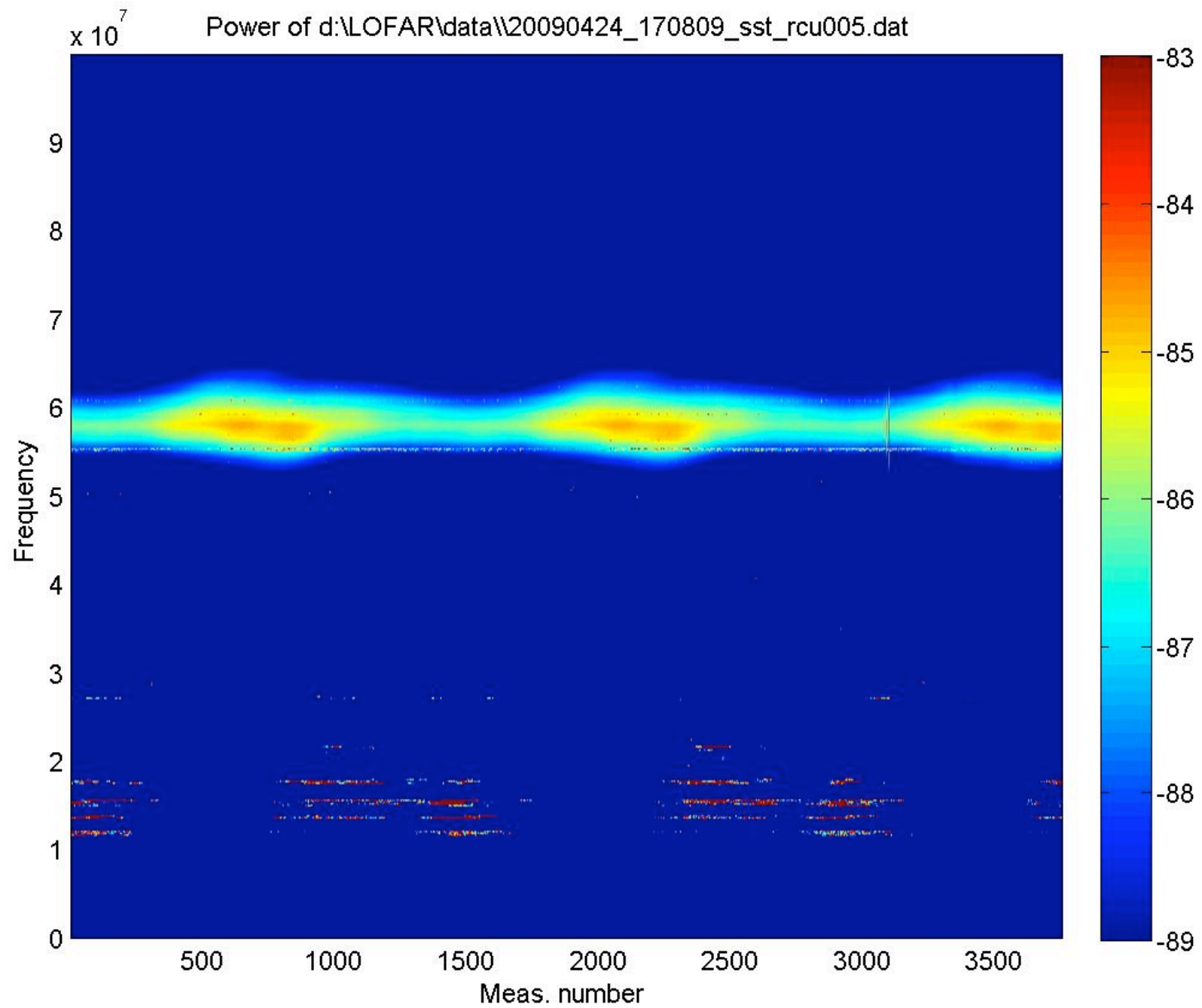

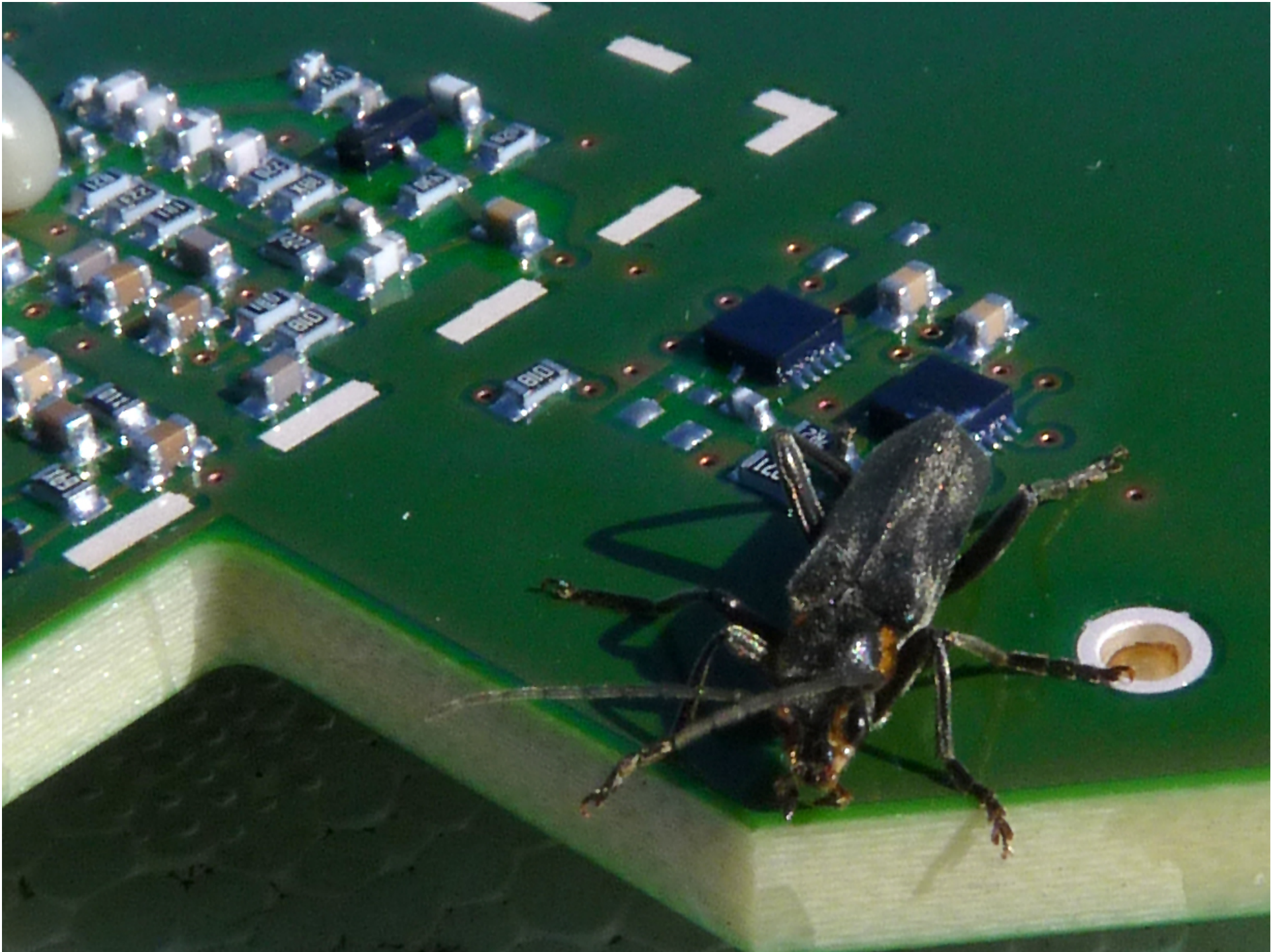

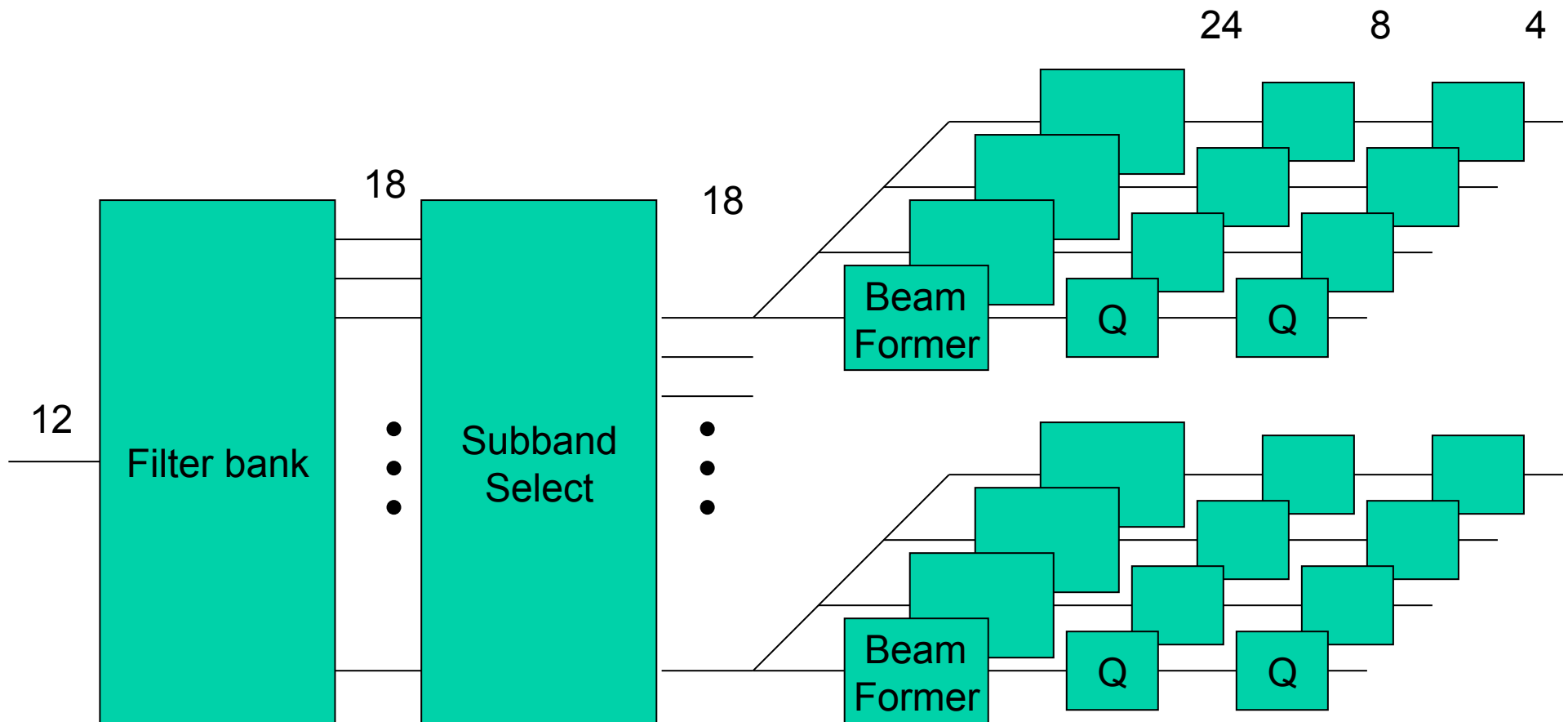

Expected availability:
late 2009/early 2010

Clock frequency	160	200	MHz
Sub-band width	156.25	195.3	kHz
# sub-bands / RSP	62	62	
Total # sub-bands	248	248	
Bandwidth	38.75	48.44	MHz
Data rate / RSP	620	775	Mb/s
Total data rate	2.48	3.1	Gb/s

Expected availability: June 2009

ASTRON



CIT

OCN

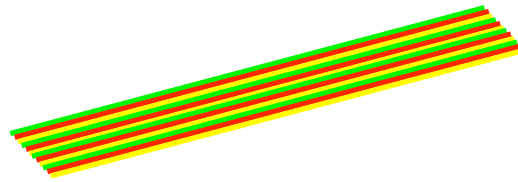

CN

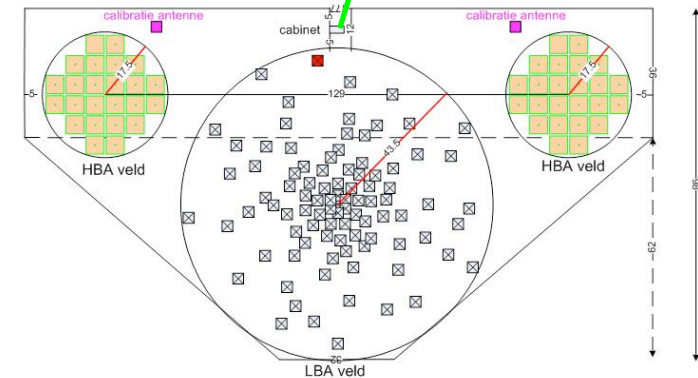
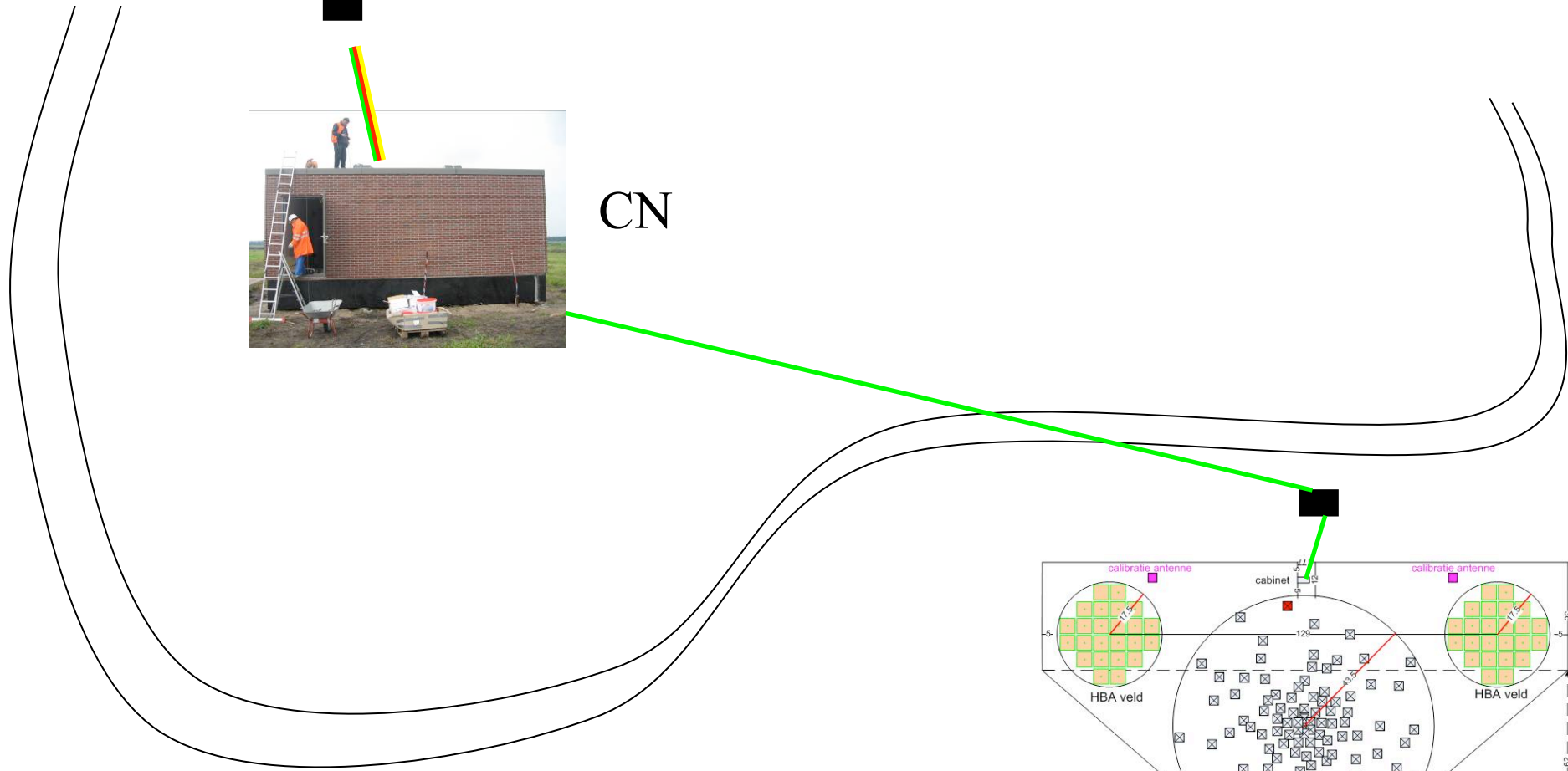

© ASTRON

LOFAR CORE station:
=> LBA veld heeft diameter van 87 meter en bevat 96 antennes
=> 2 HBA velden (elk met een diameter van 35 meter) bevatten elk 24 antennes

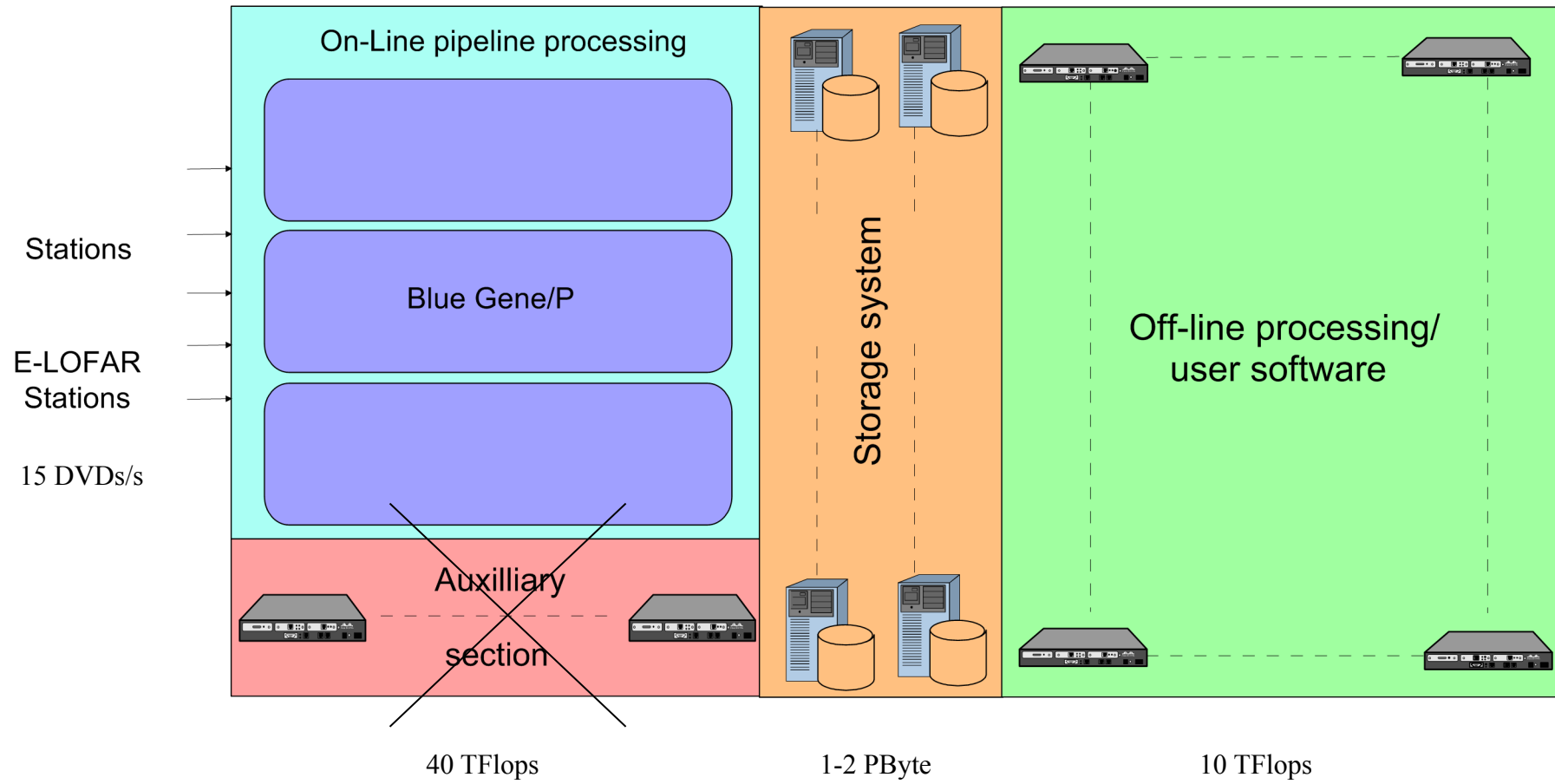

- Receive data streams from each station
- Buffer the data stream
- Synchronise input streams
- Apply delay compensation (over complete sample periods)
- Route data to correct compute node
- High volume processing
- Data reduction

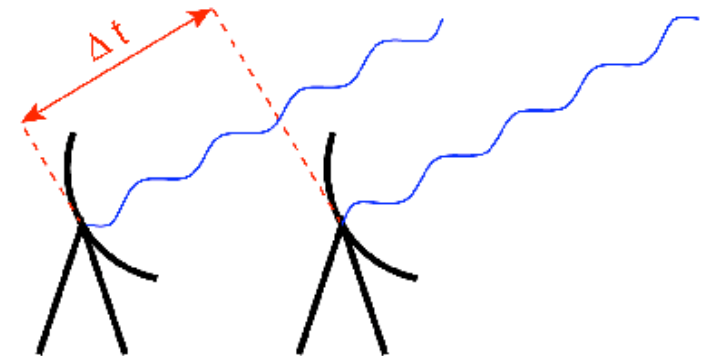

- Short term storage (~5 days)
- Store results of on-line processing
- Creates observation files from the BG/P output
- Provide data for off-line processing
- Store intermediate results for off-line processing

- Create end products
- Dependent on the observation mode
- Data reduction
- Prepare data for export out of LOFAR

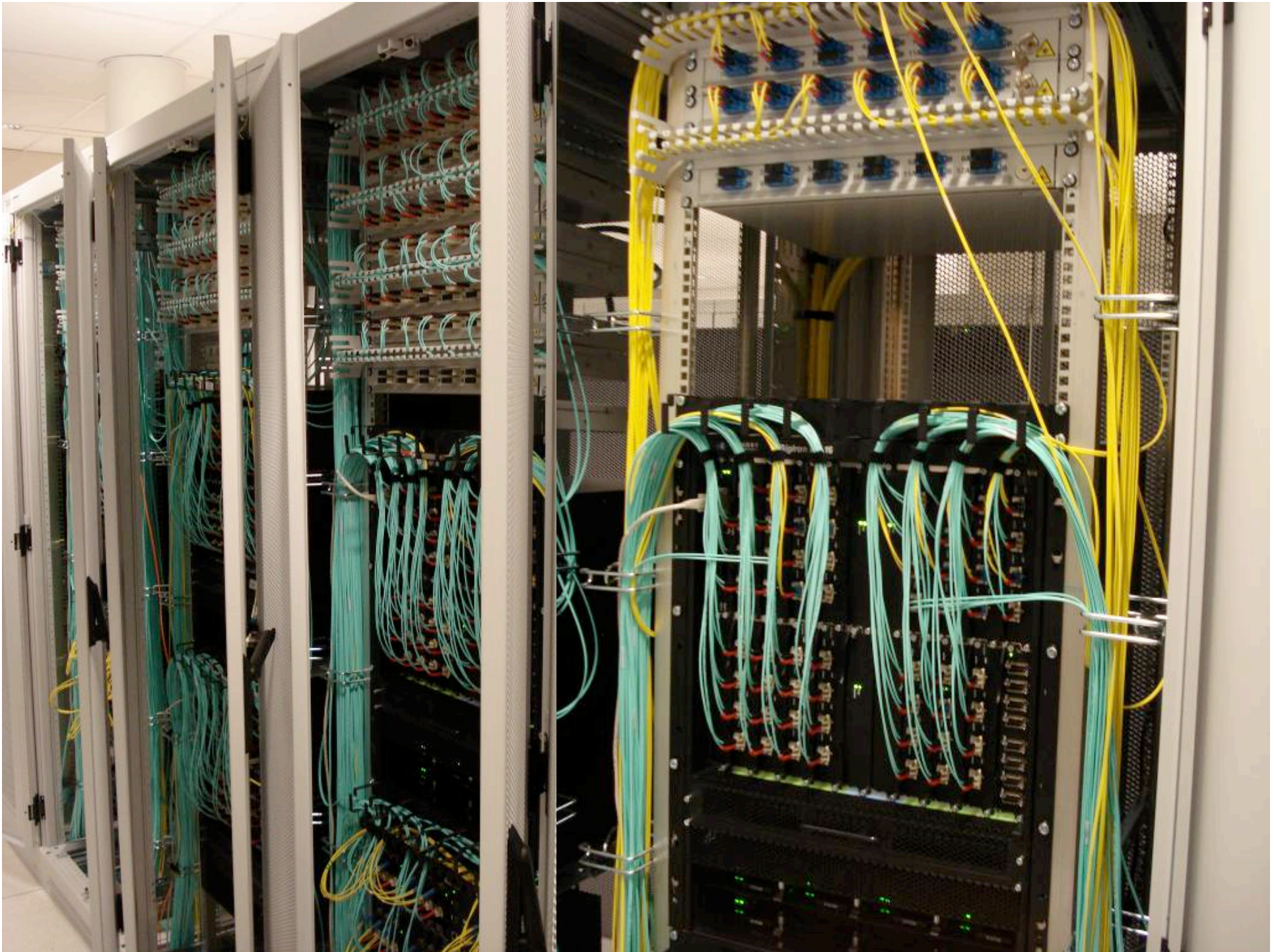

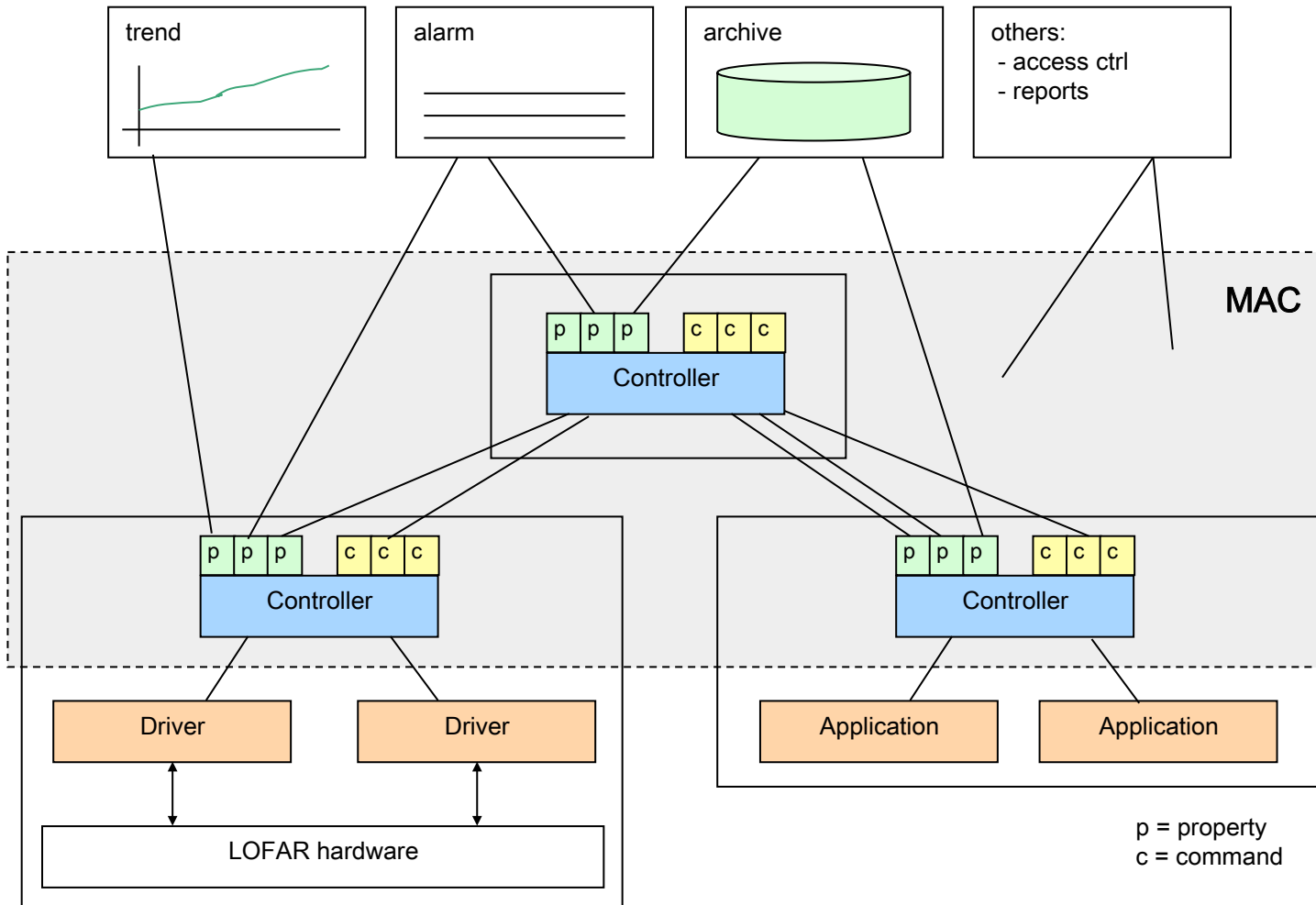

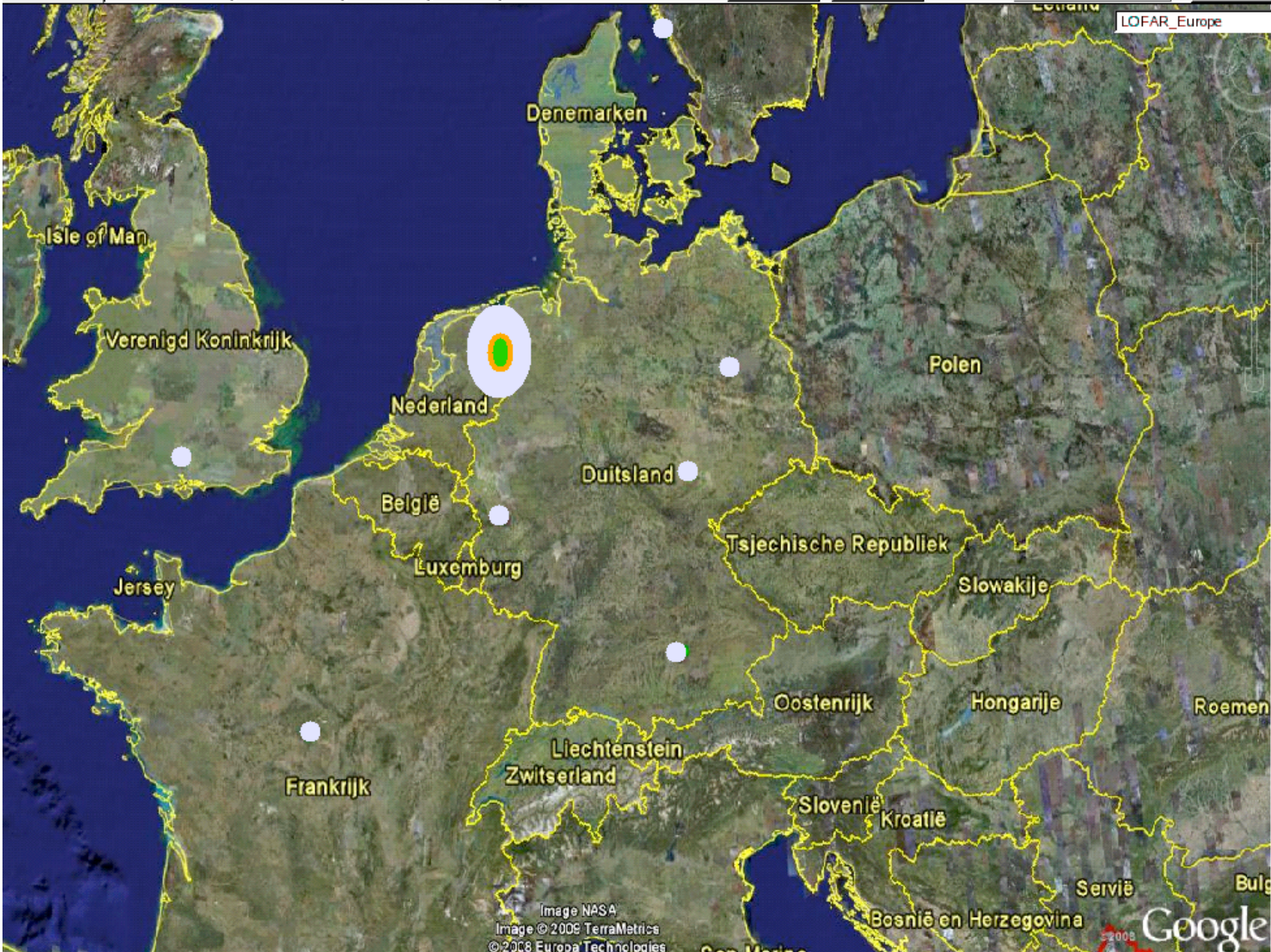

Hardware

- Hardware
- Core
- Remote
- DE601
- DE602
- DE603
- DE604
- FR606
- SE607
- UK608

Processes

- Processes

Locator

- Ping

Hardware MCU001LOFAR_PIC_Europe

2009.01.12 10:28:35.9	CS016:LOFAR_PIC_Cabinet0_Subrack0_RSPBoard2	SHM:http://10.144.0.1/shm/data/rsp/cs016/image/2/?ep	ACK
2009.01.12 10:27:45.5	CS016:LOFAR_PIC_Cabinet0_Subrack0_RSPBoard3_RCU29	SHM:http://10.144.0.1/shm/data/sst/cs016/image/29/?e	ACK
2009.01.12 10:28:30.0	CS001:LOFAR_PIC_Cabinet0_Subrack0_RSPBoard2_RCU18	SHM:http://10.144.0.1/shm/data/sst/cs001/image/18/?e	ACK

58 / 69

T B

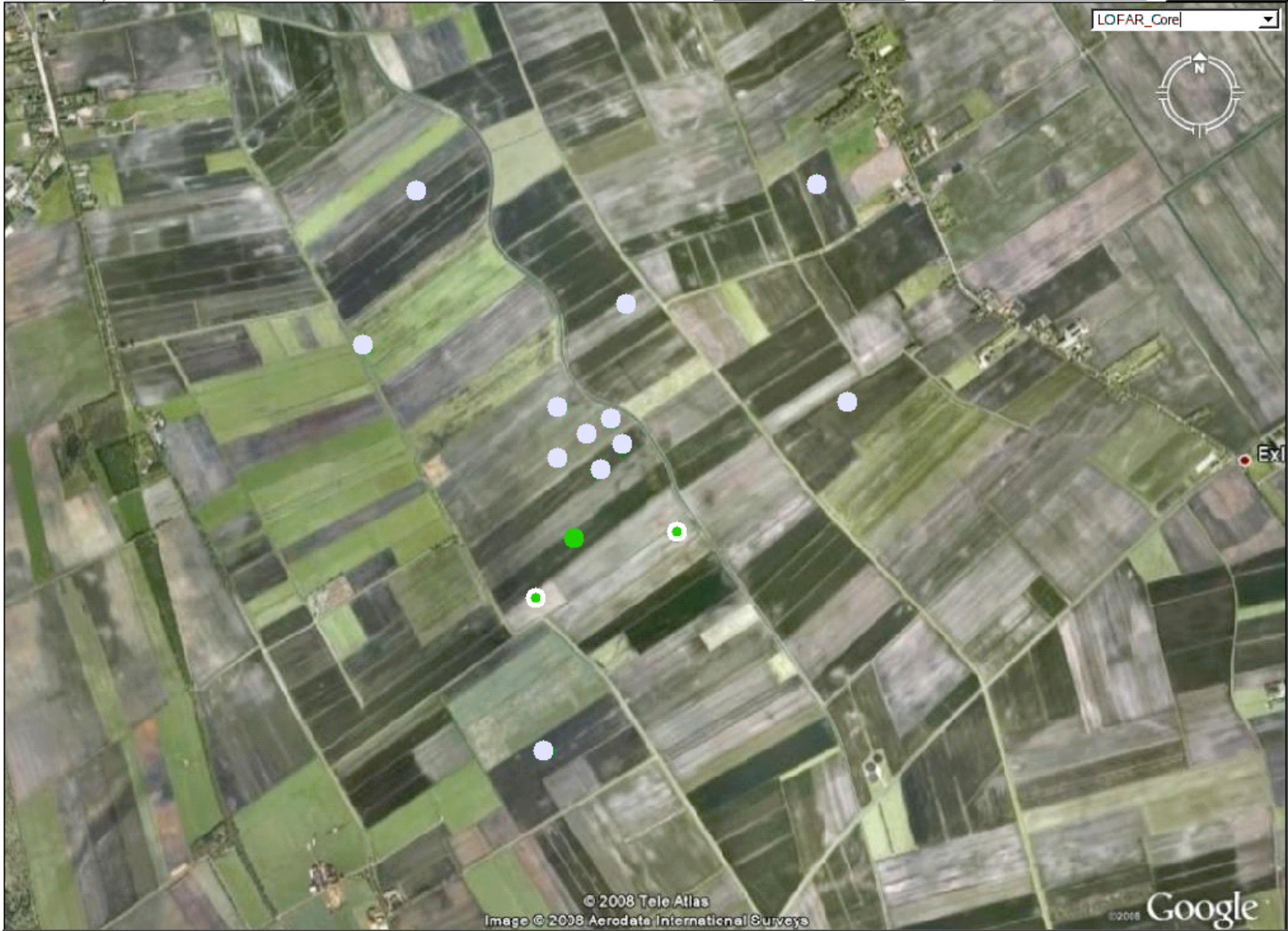

Hardware

Hardware

- CS001
- CS002
- CS003
- CS004
- CS005
- CS006
- CS007
- CS010
- CS012
- CS016
- CS026
- CS027
- CS030
- CS031
- CS032

Processes

Processes

Locator

- Ping

Hardware MCU001.LOFAR_PIC_Core

2009.01.12 10:28:35.9	CS016:LOFAR_PIC_Cabinet0_Subrack0_RSPBoard2	SHM:http://10.144.0.1/shm/data/rsp/cs016/image/2/?ep	ACK
2009.01.12 10:27:45.5	CS016:LOFAR_PIC_Cabinet0_Subrack0_RSPBoard3_RCU29	SHM:http://10.144.0.1/shm/data/sst/cs016/image/29/?ep	ACK
2009.01.12 10:28:30.0	CS001:LOFAR_PIC_Cabinet0_Subrack0_RSPBoard2_RCU18	SHM:http://10.144.0.1/shm/data/sst/cs001/image/18/?ep	ACK

58 / 69

T

B

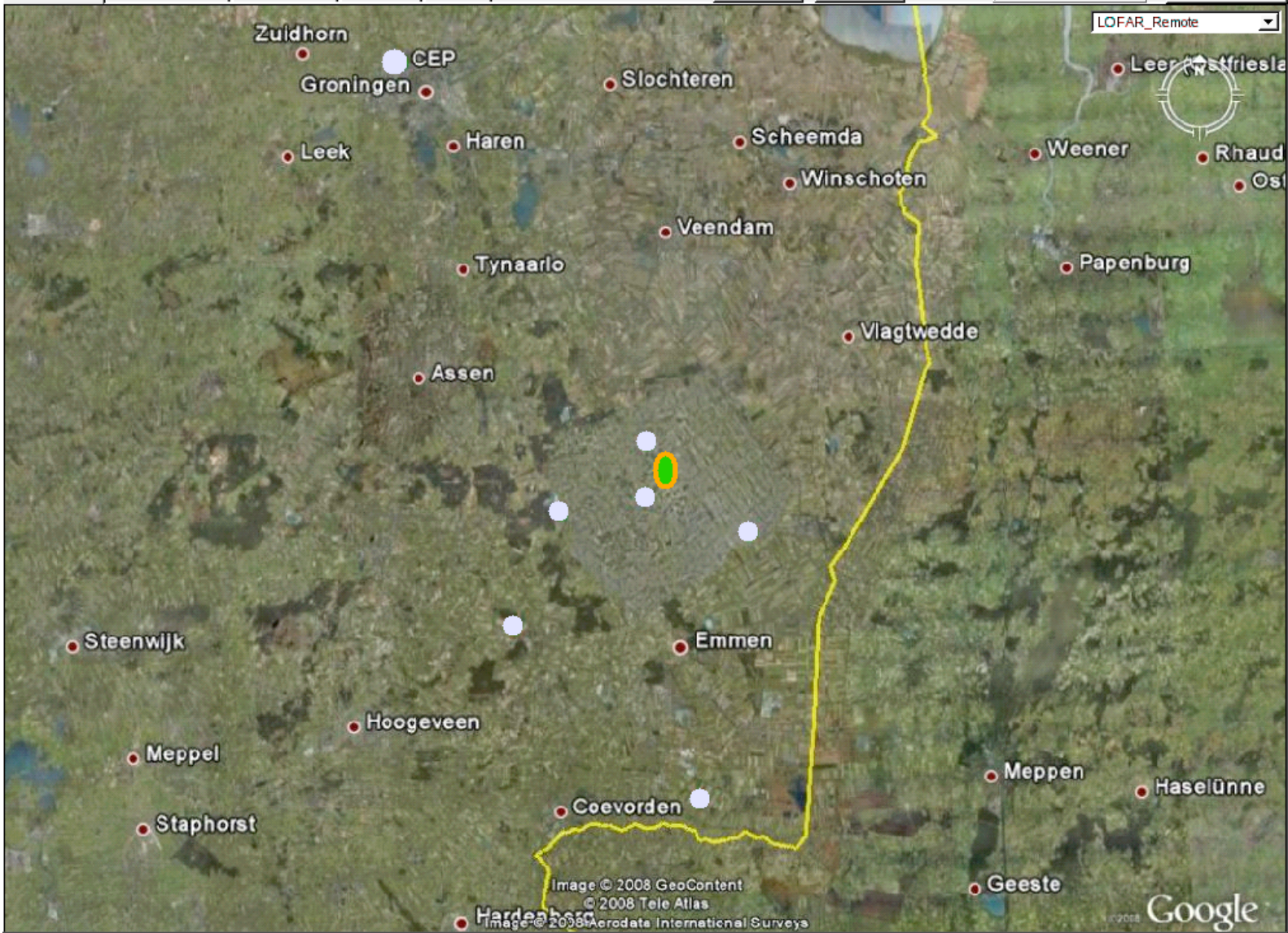

Hardware

- Hardware
- CEP
- Core
- RS106
- RS208
- RS302
- RS306
- RS307
- RS503

Processes

Processes

Locator

- Ping

Hardware MCU001:LOFAR_PIC_Remote

2009.01.12 10:28:35.9	CS016:LOFAR_PIC_Cabinet0_Subrack0_RSPBoard2	SHM:http://10.144.0.1/shm/data/rsp/cs016/image/2/?ep	ACK
2009.01.12 10:27:45.5	CS016:LOFAR_PIC_Cabinet0_Subrack0_RSPBoard3_RCU29	SHM:http://10.144.0.1/shm/data/sst/cs016/image/29/?e	ACK
2009.01.12 10:28:30.0	CS001:LOFAR_PIC_Cabinet0_Subrack0_RSPBoard2_RCU18	SHM:http://10.144.0.1/shm/data/sst/cs001/image/18/?e	ACK

58 / 69

T B

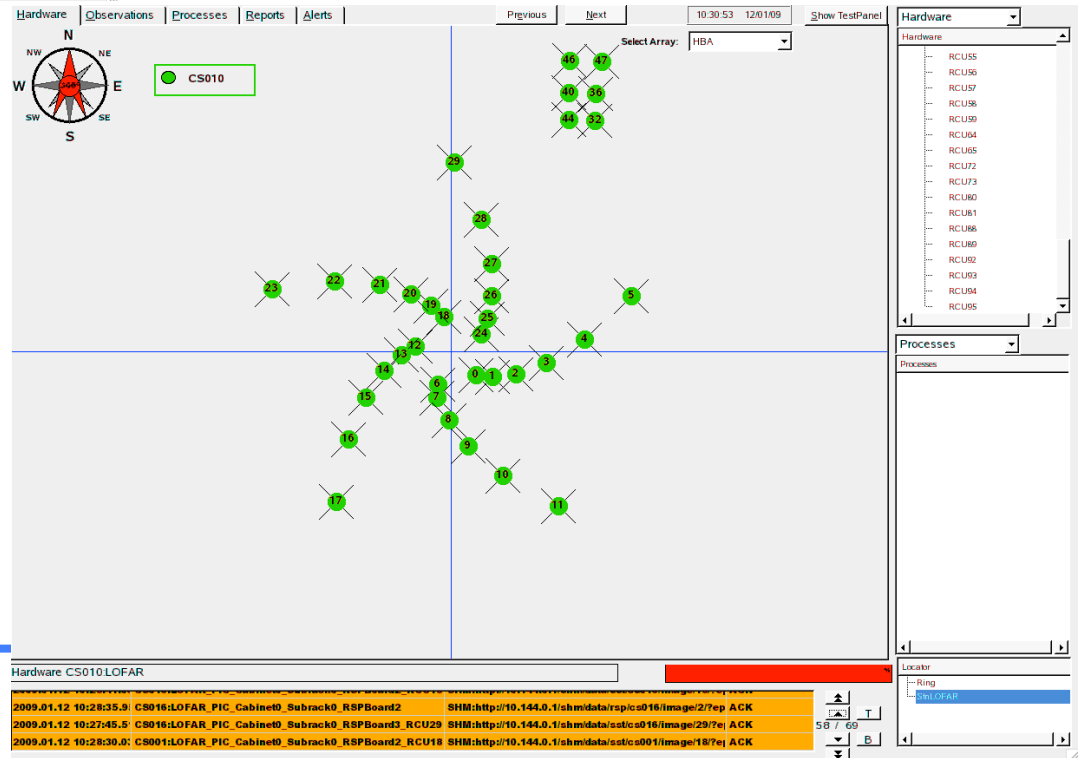
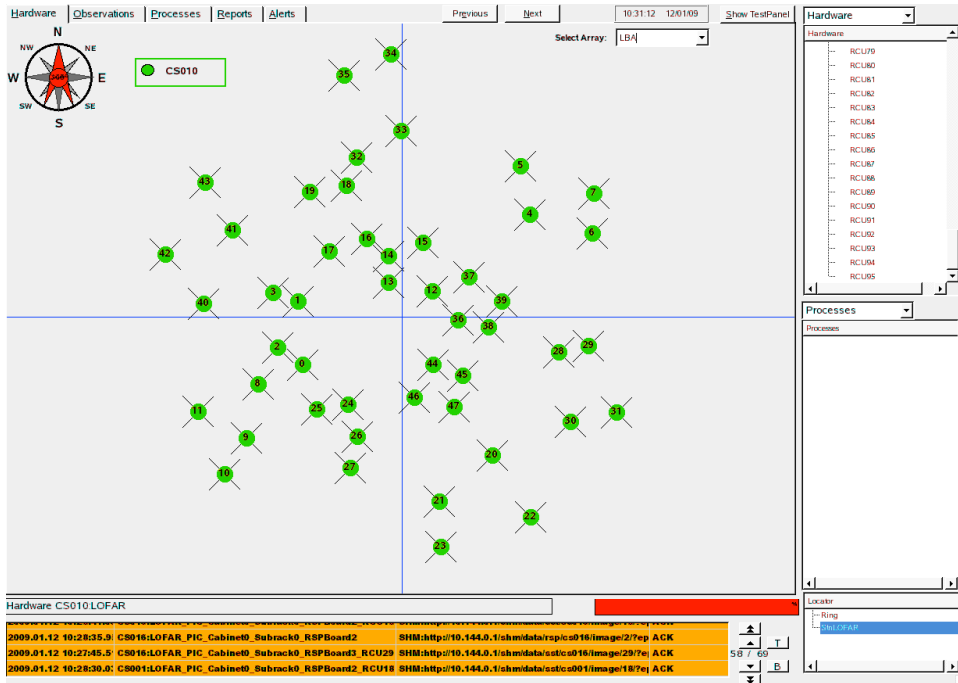

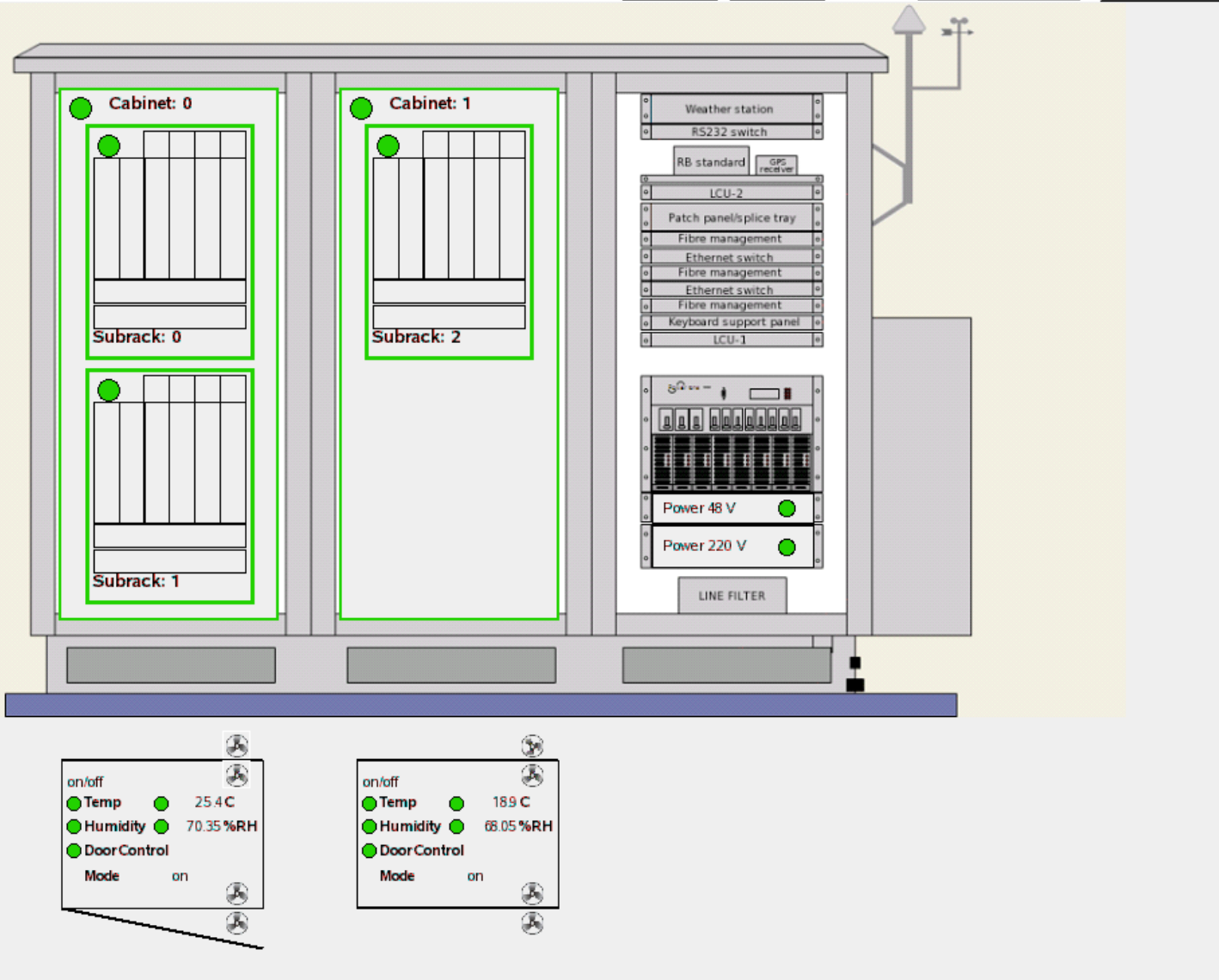

Hardware

- Hardware
 - CS010
 - Cabinet0
 - Subrack0
 - Subrack1
 - Cabinet1
 - Subrack2

Processes

Processes

Hardware CS010:LOFAR_PIC

2009.01.12 10:28:35.9	CS016:LOFAR_PIC_Cabinet0_Subrack0_RSPBoard2	SHM:http://10.144.0.1/shm/data/rspics016/image/2/?ep	ACK
2009.01.12 10:27:45.5	CS016:LOFAR_PIC_Cabinet0_Subrack0_RSPBoard3_RCU29	SHM:http://10.144.0.1/shm/data/sst/cs016/image/29/?e	ACK
2009.01.12 10:28:30.0	CS001:LOFAR_PIC_Cabinet0_Subrack0_RSPBoard2_RCU18	SHM:http://10.144.0.1/shm/data/sst/cs001/image/18/?e	ACK

58 / 69

T

B

Locator

- Ring
- StnLOFAR
- StnPIC

Station: CS010
 Cabinet: 0
 Subrack: 0

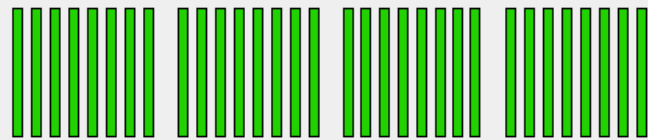

TBBoard0	TBBoard1	RSP: 0	RSP: 1	RSP: 2	RSP: 3
Voltage 1.2: 0.00 V	Voltage 1.2: 0.00 V	Voltage 1.2: 1.18 V	Voltage 1.2: 1.18 V	Voltage 1.2: 1.18 V	Voltage 1.2: 1.18 V
Voltage 2.5: 0.00 V	Voltage 2.5: 0.00 V	Voltage 2.5: 2.49 V	Voltage 2.5: 2.48 V	Voltage 2.5: 2.49 V	Voltage 2.5: 2.49 V
Voltage 3.3: 0.00 V	Voltage 3.3: 0.00 V	Voltage 3.3: 3.20 V	Voltage 3.3: 3.23 V	Voltage 3.3: 3.20 V	Voltage 3.3: 3.23 V
ver: x.x	ver: x.x	ver: 0	ver: 0	ver: 0	ver: 0

Clock Board 16.00 °C Freq. 200 Mhz
 Vfsp 0.00 V Clock 4.97 V lock160 lock200 ver: x.x

SPU Board 0.00 °C

Hardware

- RCU16
- RCU17
- RCU18
- RCU19
- RCU20
- RCU21
- RCU22
- RCU23
- RSPBoard3
 - RCU24
 - RCU25
 - RCU26
 - RCU27
 - RCU28
 - RCU29
 - RCU30
 - RCU31

Processes

Processes

Locator

- StnLOFAR
- StnPIC
- Cabinet
- SubPack

Hardware CS010:LOFAR_PIC_Cabinet0_Subrack0

2009.01.12 10:28:35.9	CS016:LOFAR_PIC_Cabinet0_Subrack0_RSPBoard2	SHM:http://10.144.0.1/shm/data/rsp/cs016/image/2/?ep ACK
2009.01.12 10:27:45.5	CS016:LOFAR_PIC_Cabinet0_Subrack0_RSPBoard3_RCU29	SHM:http://10.144.0.1/shm/data/sst/cs016/image/29/?e ACK
2009.01.12 10:28:30.0	CS001:LOFAR_PIC_Cabinet0_Subrack0_RSPBoard2_RCU18	SHM:http://10.144.0.1/shm/data/sst/cs001/image/18/?e ACK

58 / 69

T B

View: CS010:LOFAR_PIC_Cabinet0_Subrack0_RSPBoard1

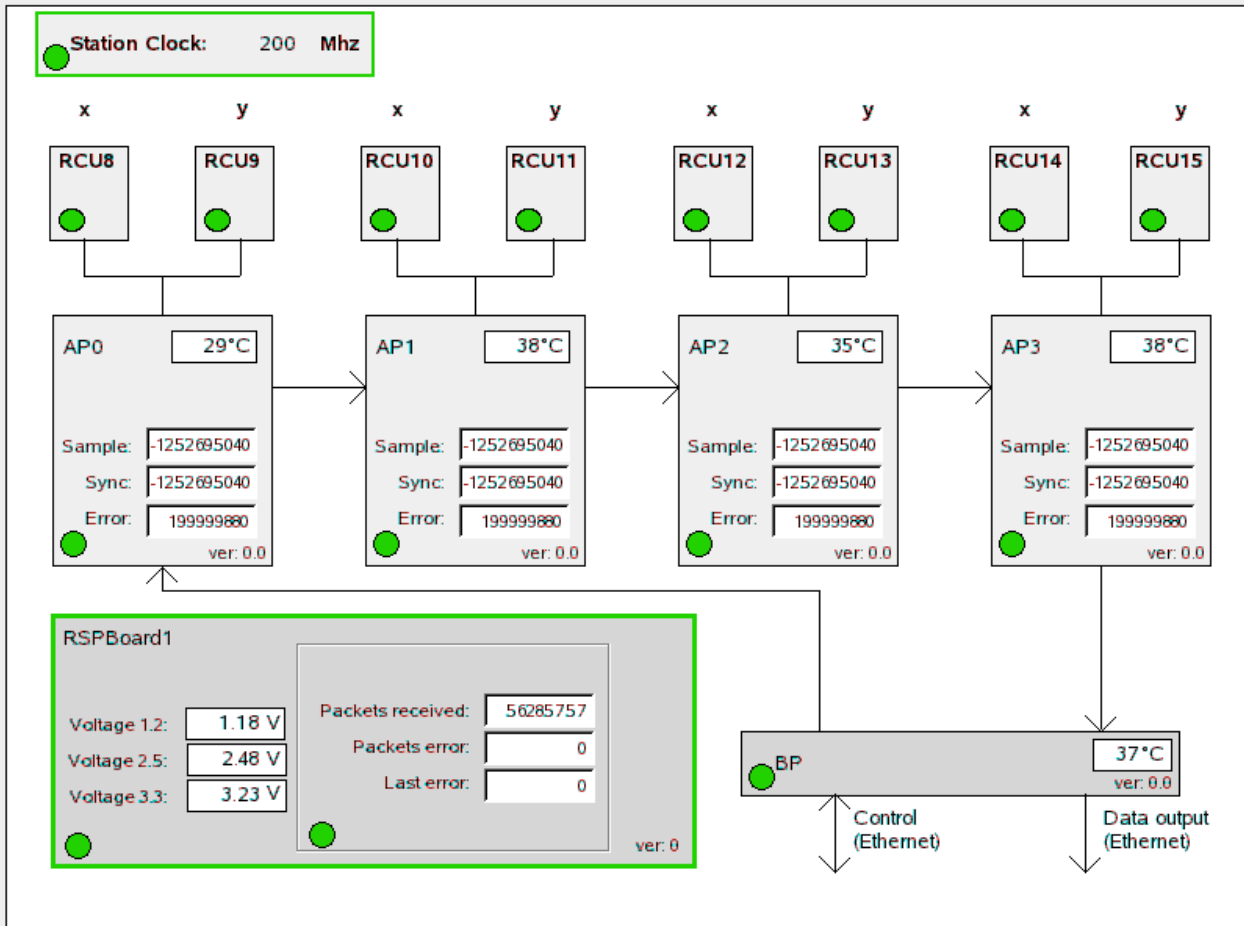

Hardware

Hardware

- CS010
 - RSPBoard1
 - RCU10
 - RCU11
 - RCU12
 - RCU13
 - RCU14
 - RCU15
 - RCU8
 - RCU9

Processes

Processes

Locabr

- ... SlnPIC
- ... Cabinet
- ... SubRack
- ... RSPBoard

Hardware CS010:LOFAR_PIC_Cabinet0_Subrack0_RSPBoard1

2009.01.12 10:28:35.9	CS016:LOFAR_PIC_Cabinet0_Subrack0_RSPBoard2	SHM:http://10.144.0.1/shm/data/rspics016/image/2/?ep	ACK
2009.01.12 10:27:45.5	CS016:LOFAR_PIC_Cabinet0_Subrack0_RSPBoard3_RCU29	SHM:http://10.144.0.1/shm/data/sst/cs016/image/29/?e	ACK
2009.01.12 10:28:30.0	CS001:LOFAR_PIC_Cabinet0_Subrack0_RSPBoard2_RCU18	SHM:http://10.144.0.1/shm/data/sst/cs001/image/18/?e	ACK

58 / 69

T

B

The End

